

User Manual

PV Grid-Connected Inverter

SG25CX-P2 / SG30CX-P2 / SG33CX-P2 / SG36CX-P2 /
SG40CX-P2/ SG50CX-P2



All Rights Reserved

All Rights Reserved

No part of this document can be reproduced in any form or by any means without the prior written permission of Sungrow Power Supply Co., Ltd (hereinafter "SUNGROW").

Trademarks

SUNGROW and other Sungrow trademarks used in this manual are owned by SUNGROW.

All other trademarks or registered trademarks mentioned in this manual are owned by their respective owners.

Software Licenses

- It is prohibited to use data contained in firmware or software developed by SUNGROW, in part or in full, for commercial purposes by any means.
- It is prohibited to perform reverse engineering, cracking, or any other operations that compromise the original program design of the software developed by SUNGROW.

About This Manual

The manual mainly contains the product information, as well as guidelines for installation, operation, and maintenance. The manual does not include complete information about the photovoltaic (PV) system. Readers can get additional information at www.sungrowpower.com or on the webpage of the respective component manufacturer.

Validity

This manual is valid for the following model of low-power grid-connected PV string inverters:

- SG25CX-P2
- SG30CX-P2
- SG33CX-P2
- SG36CX-P2
- SG40CX-P2
- SG50CX-P2

It will be referred to as "inverter" hereinafter unless otherwise specified.

Target Group

This manual is intended for professional technicians who are responsible for installation, operation, and maintenance of inverters, and users who need to check inverter parameters.

The inverter must only be installed by professional technicians. The professional technician is required to meet the following requirements:

- Know electronic, electrical wiring and mechanical expertise, and be familiar with electrical and mechanical schematics.
- Have received professional training related to the installation and commissioning of electrical equipment.
- Be able to quickly respond to hazards or emergencies that occur during installation and commissioning.
- Be familiar with local standards and relevant safety regulations of electrical systems.
- Read this manual thoroughly and understand the safety instructions related to operations.

How to Use This Manual

Please read this manual carefully before using the product and keep it properly at a place for easy access.

All contents, pictures, marks, and symbols in this manual are owned by SUNGROW. No part of this document may be reprinted by the non-internal staff of SUNGROW without written authorization.

Contents of this manual may be periodically updated or revised, and the actual product purchased shall prevail. Users can obtain the latest manual from support.sungrowpower.com or sales channels.

Symbols

This manual contains important safety instructions, which are highlighted with the following symbols, to ensure personal and property safety during usage, or to help optimize the product performance in an efficient way.

Please carefully understand the meaning of these warning symbols to better use the manual.

DANGER

Indicates high-risk potential hazards that, if not avoided, may lead to death or serious injury.

WARNING

Indicates moderate-risk potential hazards that, if not avoided, may lead to death or serious injury.

CAUTION

Indicates low-risk potential hazards that, if not avoided, may lead to minor or moderate injury.

NOTICE

Indicates potential risks that, if not avoided, may lead to device malfunctions or financial losses.



“NOTE” indicates additional information, emphasized contents or tips that may be helpful, e.g., to help you solve problems or save time.

Contents

All Rights Reserved	I
About This Manual	II
1 Safety Instructions	1
1.1 Unpacking and Inspection	1
1.2 Installation Safety	1
1.3 Electrical Connection Safety	2
1.4 Operation Safety	3
1.5 Maintenance Safety	4
1.6 Disposal Safety	4
2 Product Description	5
2.1 System Introduction	5
2.2 Product Introduction	6
2.3 Symbols on the Product	8
2.4 LED Indicator	9
2.5 Circuit Diagram	10
2.6 Function Description	10
3 Unpacking and Storage	13
3.1 Unpacking and Inspection	13
3.2 Inverter Storage	13
4 Mechanical Mounting	15
4.1 Safety during Mounting	15
4.2 Location Requirements	15
4.2.1 Environment Requirements	16
4.2.2 Carrier Requirements	16
4.2.3 Angle Requirements	17
4.2.4 Clearance Requirements	18
4.3 Installation Tools	20
4.4 Moving the Inverter	21
4.5 Installing the mounting-bracket	22
4.5.1 Bracket-Mounted Installation	22
4.5.2 Wall-Mounted Installation	23

4.5.3 Pole Installation	24
4.6 Installing the Inverter.....	25
5 Electrical Connection	27
5.1 Safety Instructions	27
5.2 Terminal Description	28
5.3 Electrical Connection Overview	29
5.4 Crimp OT / DT terminal	32
5.5 External Grounding Connection	33
5.5.1 External Grounding Requirements.....	33
5.5.2 Connection Procedure.....	34
5.6 AC Cable Connection	34
5.6.1 AC Side Requirements	34
5.6.2 Requirements for OT/DT Terminal	36
5.6.3 Connection Procedure.....	36
5.7 DC Cable Connection	40
5.7.1 PV Input Configuration	41
5.7.2 Assembling the PV Connectors	42
5.7.3 Installing the PV Connector.....	43
5.8 Communication Connection	44
5.8.1 Wireless Communication Module Connection (optional).....	44
5.8.2 WiNet-S Connection (optional).....	45
5.8.3 RS485 Connection	47
5.8.4 Smart Energy Meter Connection	50
5.8.5 Dry Contact Connection.....	51
5.8.6 DRM Connection.....	52
6 Commissioning	56
6.1 Inspection before Commissioning	56
6.2 Commissioning Procedure	56
7 iSolarCloud App	58
7.1 Brief Introduction	58
7.2 Installing the App.....	58
7.3 Login	59
7.3.1 Requirements	59
7.3.2 Login Procedure	59
7.4 Function Overview.....	64
7.5 Home page	64

7.6 Run Information.....	66
7.7 Records.....	68
7.8 More.....	70
7.8.1 System Parameters.....	70
7.8.2 Operation Parameters.....	71
7.8.3 Power Regulation Parameters.....	73
7.8.4 Communication Parameters.....	78
7.8.5 Firmware Update.....	78
7.8.6 Password Changing.....	79
8 System Decommissioning.....	81
8.1 Disconnecting the Inverter.....	81
8.2 Dismantling the Inverter.....	81
8.3 Disposal of the Inverter.....	82
9 Troubleshooting and Maintenance.....	83
9.1 Troubleshooting.....	83
9.2 Maintenance.....	91
9.2.1 Maintenance Notices.....	91
9.2.2 Routine Maintenance.....	92
9.2.3 Cleaning Air Inlet and Outlet.....	93
9.2.4 Fan Maintenance.....	93
10 Appendix.....	95
10.1 Technical Data.....	95
10.2 Wring Distance of DI Dry Contact.....	102
10.3 Quality Assurance.....	104
10.4 Contact Information.....	104

1 Safety Instructions

When installing, commissioning, operating, and maintaining the product, strictly observe the labels on the product and the safety requirements in the manual. Incorrect operation or work may cause:

- Injury or death to the operator or a third party.
- Damage to the product and other properties.



- The safety instructions in this manual are only supplements and cannot cover all the precautions that should be followed. Perform operations considering actual onsite conditions.
- SUNGROW shall not be held liable for any damage caused by violation of general safety operation requirements, general safety standards, or any safety instruction in this manual.
- When installing, operating, and maintaining the product, comply with local laws and regulations. The safety precautions in this manual are only supplements to local laws and regulations.

1.1 Unpacking and Inspection

WARNING

**Check all safety signs, warning labels and nameplates on devices.
Ensure that the safety signs, warning labels and nameplates must be clearly visible and cannot be removed or covered before the device is decommissioned.**

NOTICE

After receiving the product, check whether the appearance and structural parts of the device are damaged, and check whether the packing list is consistent with the actual ordered product. If there are problems with the above inspection items, do not install the device and contact SUNGROW in time.

1.2 Installation Safety

DANGER

**Make sure there is no electrical connection before installation.
Before drilling, avoid the water and electricity wiring in the wall.**

⚠ CAUTION

Improper installation may cause personal injury!

- **If the product supports hoisting transport and is hoisted by hoisting tools, no one is allowed to stay under the product.**
- **When moving the product, be aware of the product weight and keep the balance to prevent it from tilting or falling.**

NOTICE

Before operating the product, must check and ensure that tools to be used have been maintained regularly.

1.3 Electrical Connection Safety

⚠ DANGER

Before electrical connections, please make sure that the inverter is not damaged, otherwise it may cause danger!

Before electrical connections, please make sure that the inverter switch and all switches connected to the inverter are set to "OFF", otherwise electric shock may occur!

⚠ DANGER

The PV string will generate lethal high voltage when exposed to sunlight.

- **Operators must wear proper personal protective equipment during electrical connections.**
- **Must ensure that cables are voltage-free with a measuring instrument before touching DC cables.**
- **Respect all safety instructions listed in relevant documents about PV strings.**
- **The inverter must not be connected to a PV string that requires positive or negative grounding.**

⚠ DANGER

Danger to life due to a high voltage inside the inverter!

- **Be sure to use special insulation tools during cable connections.**
- **Note and observe the warning labels on the product, and perform operations strictly following the safety instructions.**
- **Respect all safety instructions listed in this manual and other pertinent documents.**

⚠ WARNING

Damage to the product caused by incorrect wiring is not covered by the warranty.

- Electrical connection must be performed by professionals.
- All cables used in the PV generation system must be firmly attached, properly insulated, and adequately dimensioned.

⚠ WARNING

Check the positive and negative polarity of the PV strings, and connect the PV connectors to corresponding terminals only after ensuring polarity correctness.

During the installation and operation of the inverter, please ensure that the positive or negative poles of PV strings do not short-circuit to the ground. Otherwise, an AC or DC short-circuit may occur, resulting in equipment damage. The damage caused by this is not covered by the warranty.

NOTICE

Comply with the safety instructions related to PV strings and the regulations related to the local grid.

1.4 Operation Safety

⚠ DANGER

- When the inverter is running, do not touch its enclosure.
- When the inverter is running, it is strictly forbidden to plug and unplug any connector on the inverter.
- When the inverter is running, do not touch any wiring terminal of the inverter. Otherwise, electric shock may occur.
- When the inverter is running, do not disassemble any parts of the inverter. Otherwise, electric shock may occur.
- When the inverter is running, it is strictly forbidden to touch any hot parts of the inverter (such as the heat sink). Otherwise, it may cause burns.
- If the inverter is equipped with a DC switch, do not operate it when the inverter is running. Otherwise, device damage or personal injury may occur.

1.5 Maintenance Safety

DANGER

Risk of inverter damage or personal injury due to incorrect service!

- Before any service work, first disconnect the grid-side AC circuit breaker and check the inverter status. If the inverter indicator is off, please wait until night to disconnect the DC switch. If the inverter indicator is on, directly disconnect the DC switch.
- After the inverter is powered off for 15 minutes, measure the voltage and current with professional instrument. Only when there is no voltage nor current can operators who wear protective equipment operate and maintain the inverter.
- Even if the inverter is shut down, it may still be hot and cause burns. Wear protective gloves before operating the inverter after it cools down.

DANGER

Touching the power grid or the contact points and terminals on the inverter connected to the power grid may lead to electric shock!

- The power grid side may generate voltage. Always use a standard voltmeter to ensure that there is no voltage before touching.

CAUTION

To prevent misuse or accidents caused by unrelated personnel: Post prominent warning signs or demarcate safety warning areas around the inverter to prevent accidents caused by misuse.

NOTICE

To avoid the risk of electric shock, do not perform any other maintenance operations beyond those described in this manual. If necessary, contact your distributor first. If the problem persists, contact SUNGROW. Otherwise, the losses caused is not covered by the warranty.

1.6 Disposal Safety

WARNING

Please scrap the product in accordance with relevant local regulations and standards to avoid property losses or casualties.

2 Product Description

2.1 System Introduction

The inverter is a transformerless 3-phase PV grid-connected inverter. As an integral component in the PV power system, the inverter is designed to convert the direct current power generated from the PV modules into grid-compatible AC current and to feed the AC current into the utility grid.

The intended usage of the inverter is illustrated in the following figure.

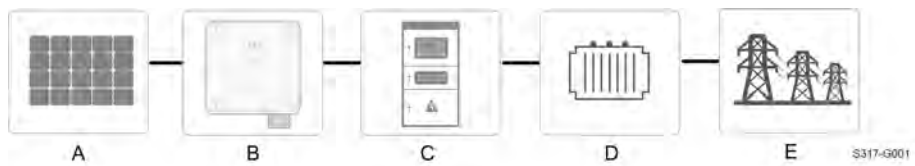

figure 2-1 Inverter Application in PV Power System

WARNING

The inverter must not be connected to a PV string that requires positive or negative grounding.

Do not connect any local load between the inverter and the AC circuit breaker.

NOTICE

The inverter applies only to the scenarios described in this manual.

Item	Description	Note
A	PV strings	Monocrystalline silicon, polycrystalline silicon and thin-film without grounding.
B	Inverter	SG25CX-P2, SG30CX-P2, SG33CX-P2, SG36CX-P2, SG40CX-P2, SG50CX-P2
C	Grid connection cabinet	Includes devices such as AC circuit breaker, SPD, metering device.
D	Transformer	Raises the output voltage of the inverter to a level that meets the requirements of the grid.
E	Utility grid	The grid forms supported by the inverter are shown in the figure below.

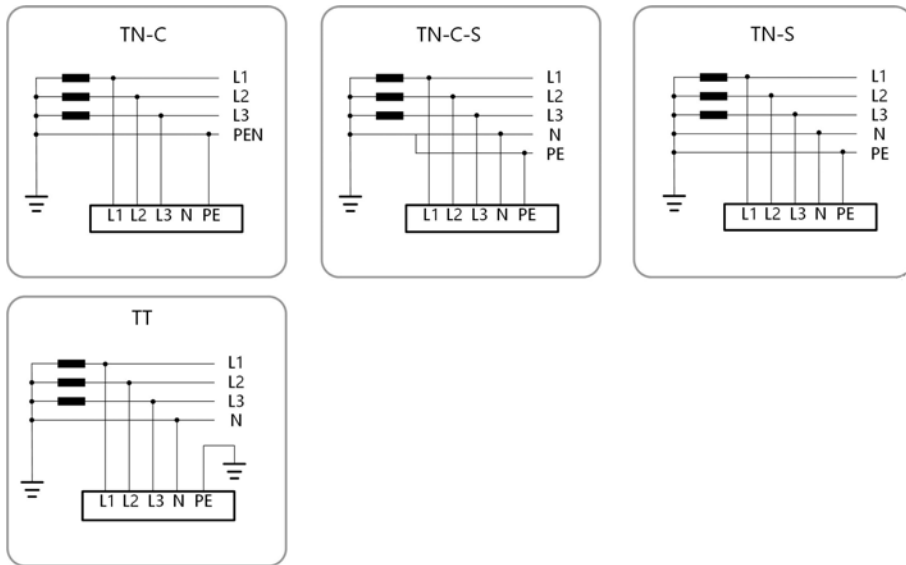

2.2 Product Introduction

Model Description

The model description is as follows (take SG30CX—P2 as an example):

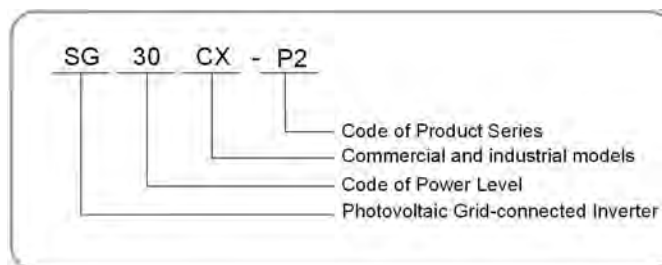

S320-G002

Appearance

The following figure shows the appearance of the inverter.

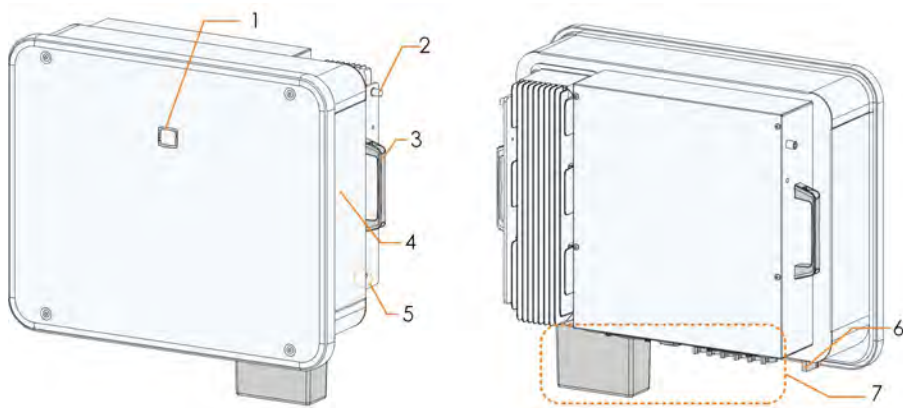

figure 2-2 Appearance

The image shown here is for reference only. The actual product received may differ.

No.	Name	Description
1	LED indicator	To indicate the current working state of the inverter.
2	Mounting ears	To hang the inverter onto the mounting-bracket.
3	Handles	To move the inverter.
4	Labels	To clearly identify the product, including Warning symbols, nameplate and QR code.
5	External ground- ing terminals	Use to ground the inverter.
6	DC switch	To safely disconnect the DC circuit whenever necessary.
7	Wiring area	DC switches, DC terminals, and communication terminals. For details, refer to "5.2 Terminal Description"

Dimensions

The following figure shows the dimensions of the inverter.





figure 2-3 Dimensions of the Inverter(in mm)

Weight

Model	Weight
SG25/30/33CX-P2	38 kg
SG36/40CX-P2	40 kg
SG50CX-P2	41 kg

2.3 Symbols on the Product

Symbol	Explanation
	Do not dispose of the inverter together with household waste.
	Read the user manual before maintenance!
	TÜV mark of conformity.
	Regulatory compliance mark.
	CE mark of conformity. EU/EEA Importer.
	UKCA mark of conformity. The height of the label should not exceed 5mm.
	The inverter does not have a transformer.
	Disconnect the inverter from all the external power sources before maintenance!





Symbol	Explanation
	<p>Danger to life due to high voltages!</p> <p>Do not touch live parts for 15 minutes after disconnection from the power sources.</p> <p>Only qualified personnel can open and maintain the inverter.</p>
	<p>External grounding point.</p>

* The table shown here is for reference only. The actual product received may differ.

2.4 LED Indicator

The LED indicator on the front of the inverter indicates the working state of the inverter.

table 2-1 State description of the LED indicator

LED color	State	Definition
 Blue	On	The device is connected to the grid and operating normally.
	Fast blink (Period: 0.2s)	The Bluetooth communication is connected and there is data communication.
	 No system fault occurs.	
	Slow blink (Period: 2s)	The device is in standby or startup state (not feeding power into the grid).
 Red	Slow blink once, fast blink three times	The inverter is performing PID recovery.
	On	A fault occurs and the device cannot connect to the grid.
 Gray	Twinkling	The Bluetooth connection is established, data communication in process, and a system fault occurs.
	OFF	Both the AC and DC sides are powered down.

WARNING

Voltage may still be present in AC side circuits after the indicator is off. Pay attention to the electricity safety during operating.

2.5 Circuit Diagram

The following figure shows the main circuit of the inverter.

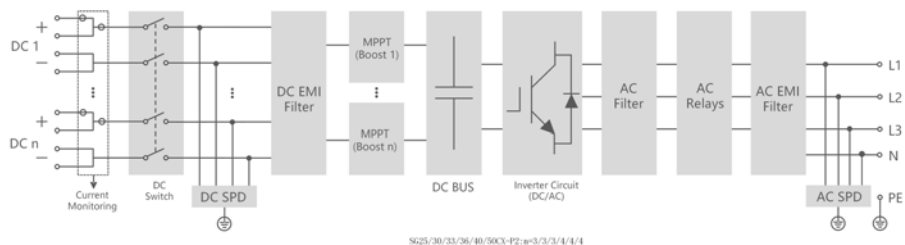

figure 2-4 Circuit Diagram

- The DC switch is used to safely disconnect the DC circuit.
- The MPPT is utilized for DC input to ensure the maximum power from the PV array at different PV input conditions.
- The inverter circuit converts the DC power into AC power and feeds it to loads (if there are) or utility grid through the AC terminal.
- The protection circuit ensures the safe operation of the device and personal safety.

2.6 Function Description

The inverter is equipped with the following functions:

Conversion Function

The inverter converts the DC current into grid-compatible AC current and feeds the AC current into the grid.

Data Storage

The inverter logs running information, error records, etc.

Parameter Configuration

The inverter provides various settable parameters. Users can set parameters via the App to meet the requirements and optimize the performance.

Communication Interface

The inverter is designed with standard RS485 communication interfaces and communication accessory port.

- The standard RS485 communication interfaces are used to establish communication with monitoring devices and to upload monitoring data to a monitoring background through communication cables.

- The communication accessory port is used to connect communication module manufactured by SUNGROW, and upload monitoring data through communication cables or wireless communication.

The inverter can be connected to communication devices via either of the two interfaces. When communication is established between the inverter and the communication devices, users can view inverter information or set inverter parameters, such as running parameter and protection parameter, through the iSolarCloud.



It is recommended to use the communication module from SUNGROW. Using a device from other companies may lead to communication failure or other unexpected damage.

Protection Function

The protective functions are integrated in the inverter, including anti-island protection, DC reversed polarity protection, AC short circuit protection, leakage current protection, etc.

Ripple Control

The inverter provides terminals (DRM) for connecting to a Ripple Control Receiver (RCR). After the connection, the grid dispatching center issues regulation instructions via dry contact (DI). The inverter can control power output according to the local preset instructions.

PID recovery

The PID effect (Potential Induced Degradation) of PV modules will cause serious damage to generated output and yield, which can be avoided or recovered by PID recovery function.

- For positive voltage scheme, after the PID is enabled, the voltage to ground of all PV strings is greater than 0, and therefore the PV string-to-ground voltage is a positive value.

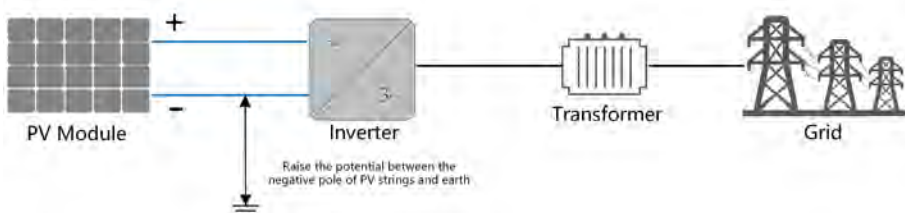

- For negative voltage scheme, after the PID is enabled, the voltage to ground of all PV strings is lower than 0, and therefore the PV string-to-ground voltage is a negative value.

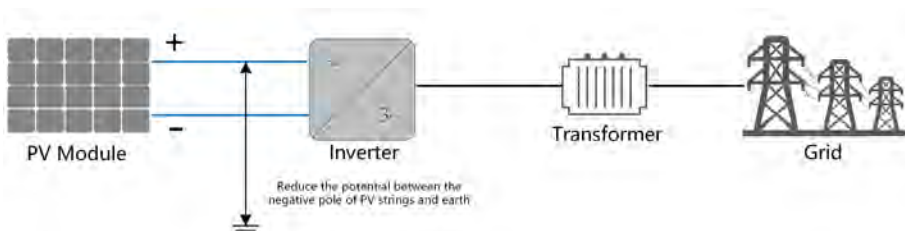

NOTICE

- **Before enabling the PID recovery function, make sure the voltage polarity of the PV modules to ground meets requirement. If there are any questions, contact the PV module manufacturer or read the corresponding user manual.**
- **PID recovery function and reactive power generation at night cannot be enabled at the same time.**
- **If the voltage scheme for the PID protection/recovery function does not meet the requirement of corresponding PV modules, the PID will not work as expected or even damage the PV modules.**
- **If the PID recovery function is enabled, it only works at night.**
- **When the inverter is in the PID recovery state (the indicator blinks blue once at long intervals and blinks at short intervals for three times), disable the PID recovery in the iSolarCloud App before manually powering on and maintaining the inverter.**

AFCI Function

- AFCI activation

This function can be enabled to detect whether arc occurs in the DC circuit of the inverter.

- AFCI self-test

This function is intended to detect whether the AFCI function of the inverter is normal.

- Clear AFCI Alarm

When the inverter detects the AFCI alarm, it stops working. Clear the AFCI alarm so that the inverter can restart the detection.

3 Unpacking and Storage

3.1 Unpacking and Inspection

The product is thoroughly tested and strictly inspected before delivery. Nonetheless, damage may still occur during shipping. For this reason, please conduct a thorough inspection after receiving the product.

- Check the packing case for any visible damage.
- Check the scope of delivery for completeness according to the packing list.
- Check the inner contents for damage after unpacking.

Contact SUNGROW or the transport company in case of any damage or incompleteness, and provide photos to facilitate services.

Do not dispose of the original packing case. It is recommended to store the device in the original packing case when the product is decommissioned.

NOTICE

After receiving the product, check whether the appearance and structural parts of the device are damaged, and check whether the packing list is consistent with the actual ordered product. If there are problems with the above inspection items, do not install the device and contact your distributor first. If the problem persists, contact SUNGROW in time.

If any tool is used for unpacking, be careful not to damage the product.

3.2 Inverter Storage

Proper storage is required if the inverter is not installed immediately.

- Store the inverter in the original packing case with the desiccant inside.
- The storage temperature must be always between -40°C and $+70^{\circ}\text{C}$, and the storage relative humidity must be always between 0 and 95 %, non-condensing.
- In case of stacking storage, the number of stacking layers should never exceed the limit marked on the outer side of the packing case.
- The packing case should be upright.
- If the inverter needs to be transported again, pack it strictly before loading and transporting it.

- Do not store the inverter in places susceptible to direct sunlight, rain, and strong electric field.
- Do not place the inverter in places with items that may affect or damage the inverter.
- Store the inverter in a clean and dry place to prevent dust and water vapor from eroding.
- Do not store the inverter in places with corrosive substances or susceptible to rodents and insects.
- Carry out periodic inspections. Inspection shall be conducted at least once every six months. If any insect or rodent bites are found, replace the packaging materials in time.
- If the inverter has been stored for more than a year, inspection and testing by professionals are required before it can be put into operation.

NOTICE

Please store the inverter according to the storage requirements. Product damage caused by failure to meet the storage requirements is not covered by the warranty.

4 Mechanical Mounting

WARNING

Respect all local standards and requirements during mechanical installation.

4.1 Safety during Mounting

DANGER

Make sure there is no electrical connection before installation.
Before drilling, avoid the water and electricity wiring in the wall.

WARNING

Poor installation environment will affect system performance!

- Install the inverter in a well-ventilated place.
- Ensure that the heat dissipation system or vent is not blocked.
- Do not install the inverter in an environment with flammable and explosive objects or smoke.

CAUTION

Improper handling may cause personal injury!

- When moving the inverter, be aware of its weight and keep the balance to prevent it from tilting or falling.
- Wear proper protective equipment before performing operations on the inverter.
- The bottom terminals and interfaces of the inverter cannot directly contact the ground or other supports. The inverter cannot be directly placed on the ground.

4.2 Location Requirements

Select an optimal mounting location for safe operation, long service life and expected performance.

- The inverter with protection rating IP66 can be installed both indoors and outdoors.
- Install the inverter at a place convenient for electrical connection, operation, and maintenance.

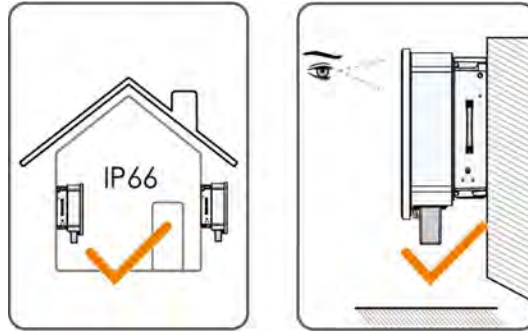

4.2.1 Environment Requirements

- The installation environment must be free of inflammable or explosive materials.
- The location should be not accessible to children.
- The ambient temperature and relative humidity must meet the following requirements.

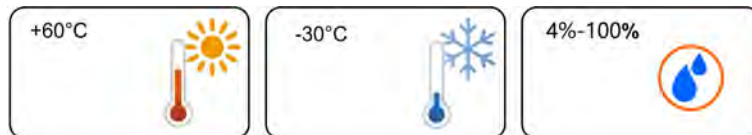

- Do not install the inverter outdoors in areas with high salinity, which mainly refer to the areas within 500 m away from the coast. The deposition of salt fog varies largely with nearby seawater characteristics, sea wind, precipitation, relative humidity, terrain, and forest coverage.
- Inverters free from direct sunlight, direct rain and snow have longer service life. Consider sheltered places as the installation location.
- The inverter should be well ventilated. Ensure air circulation.
- The inverter generates noise during operation and is not recommended to be installed in living areas.

4.2.2 Carrier Requirements

The mounting structure where the inverter is installed must comply with local/national standards and guidelines. Ensure that the installation surface is solid enough to bear four times the weight of the inverter and is suitable for the dimensions of the inverter (e.g. cement walls, plasterboard walls, etc.).



4.2.3 Angle Requirements

Install the inverter vertically or at the maximum allowable rear tilt angle. Do not install the inverter horizontally, forward, excessively backward, sideways, or upside down.

Please consult SUNGROW before tilting backwards the inverter and install it in floating power plants.

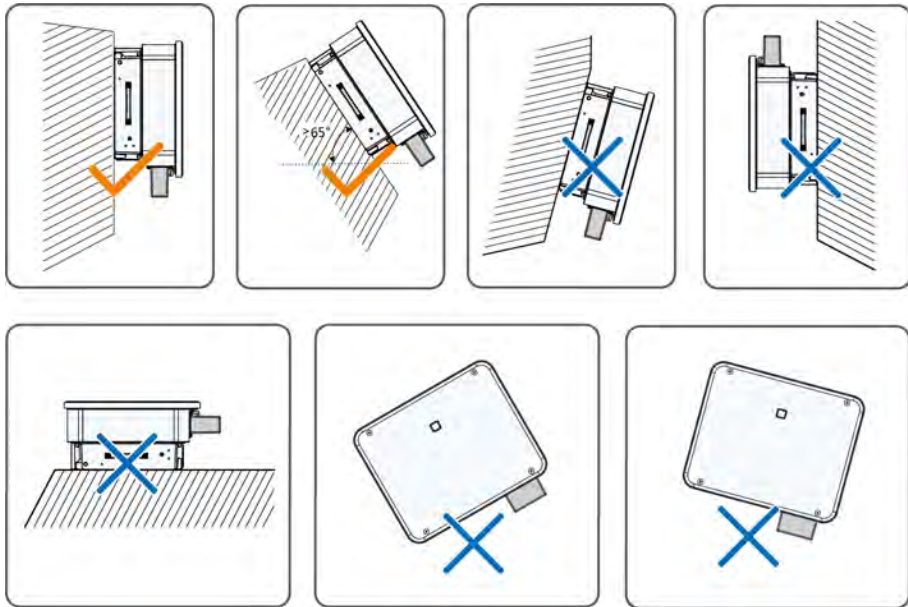

tilting backwards installation requirements

In case the installation site is a level surface, mount the inverter to the horizontal-mounting bracket to meet the mounting angle requirements, as shown in the figure below.

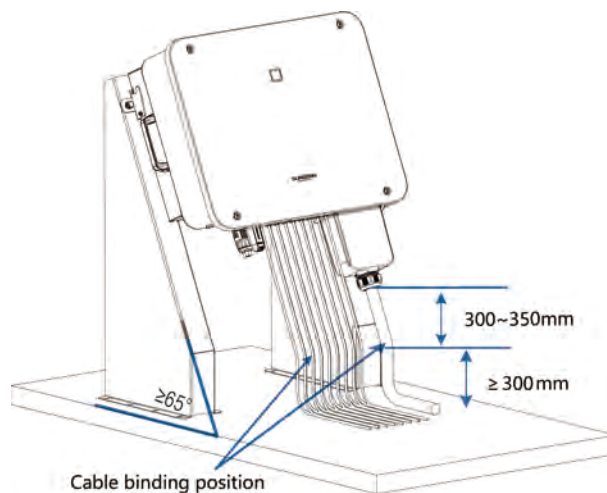

Take the following items into account when designing the bracket scheme:

- Consider onsite climate conditions and take anti-snow and anti-rain measures if necessary.

- Ensure that the waterproof connectors are at least 300mm higher than the ground surface.
- Bind the cables at the positions 300~350mm away from the DC connector, AC waterproof terminal, and communication waterproof terminal.
- The various waterproof terminals should be tightened in accordance with the torque requirements in this manual to ensure that they are tight and sealed.

4.2.4 Clearance Requirements

Reserve enough clearance around the inverter to ensure sufficient space for heat dissipation.

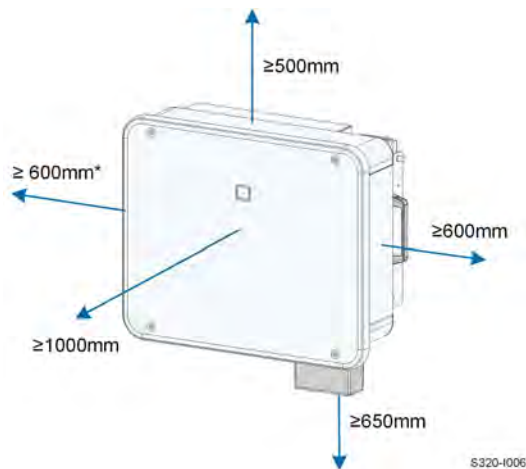

*When this distance is less than the distance shown, lift the inverter off the stand or wall before maintaining fans.

The distance from the bottom of the inverter to the ground is determined according to the bending radius of the selected AC cable and the installation environment, and the following requirements should be met :

- The distance from the bottom of the inverter to the ground should be $\geq 650\text{mm}$.
- The AC cable should be connected to the AC terminal vertically, and the length of the vertical cable should be $\geq 200\text{mm}$.

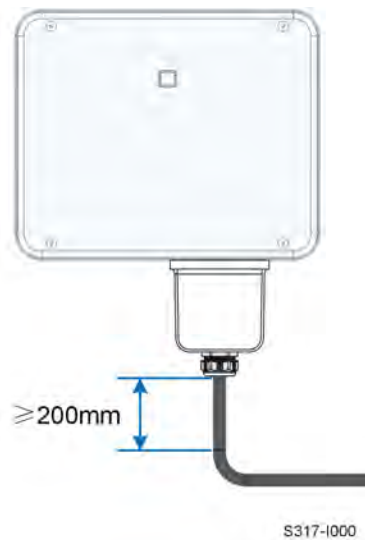

Contact the AC cable manufacturer for any questions.

In case of multiple inverters, reserve specific clearance between the inverters.

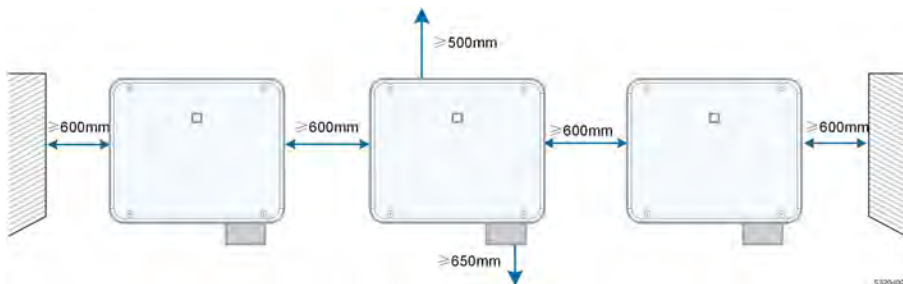

Back-to-Back Installation

When installing inverters back-to-back, the distance between every two inverters should be at least 200 mm.

Add a baffle between the two inverters to form a heat dissipation channel. The baffle plate should be placed horizontally between two inverters and should not block the air outlet of inverters.

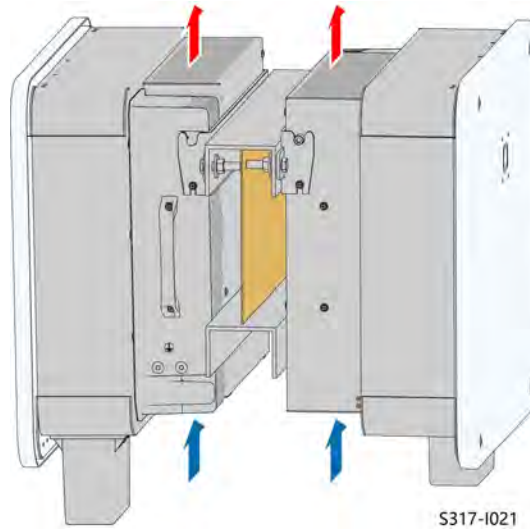

4.3 Installation Tools

Installation tools include but are not limited to the following recommended ones. If necessary, use other auxiliary tools on site.



Goggles

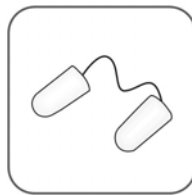

Earplugs

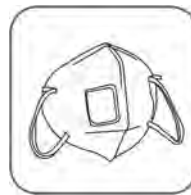

Dust mask



Protective gloves



Insulated shoes



Utility knife



Wrist strap



Marker



Level



Hammer drill

($\varnothing 12$)



Rubber mallet



Phillips screwdriver

(M4, M5, M6)



Wrench
(16 mm, 60 mm)



Socket wrench set
(M8)



Wire cutter



Wire stripper



Hydraulic plier



Heat gun



MC4-Evo2 terminal
crimping pliers
4–6mm²



MC4-Evo2 terminal
wrench



Multimeter
≥ 1100 Vdc



Vacuum cleaner

4.4 Moving the Inverter

Before installation, remove the inverter from the packing case and move it to the installation site. Follow the instructions below as you move the inverter:

- Always be aware of the weight of the inverter.
- Prevent the inverter from tilting or dropping.

Lift and move the inverter to the destination by using the side handles and bottom edge.



⚠ CAUTION

Improper handling may cause personal injury!

- Arrange an appropriate number of personnel to carry the inverter according to its weight, and installation personnel should wear protective equipment such as anti-impact shoes and gloves.
- Attention must be paid to the center of gravity of the inverter to avoid tilting during handling.
- Placing the inverter directly on a hard ground may cause damage to its metal enclosure. Protective materials such as sponge pad or foam cushion should be placed underneath the inverter.
- Move the inverter by holding the handles on it. Do not move the inverter by holding the terminals.

4.5 Installing the mounting-bracket

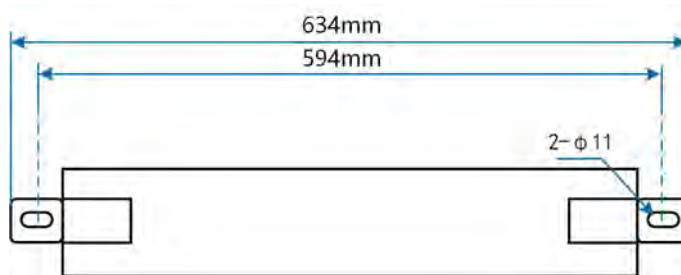

figure 4-1 Dimensions of mounting-bracket

4.5.1 Bracket-Mounted Installation

Tool preparation

Name	Specification
Marker	—
Level	-
Hammer drill	Bit: $\phi 12$
Wrench	Inner diameter: 16mm

Material preparation

Name	Quantity	Specification	Source
Bolt assembly	2	M10	Included in the delivery scope
Steel u-channel	2	-	Not included in the delivery scope

- step 1 Mark and drill holes in one steel u-channel according to the dimensions shown in the figure below. Two steel u-channels should be spaced 180 mm - 260 mm apart.

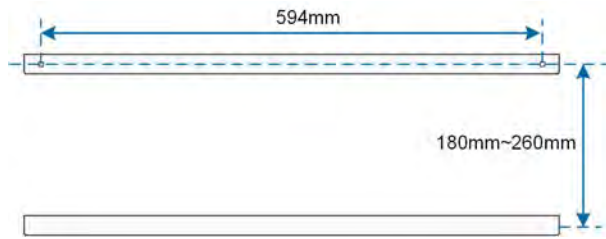

step 2 Secure the mounting-bracket to the steel u-channel with bolts.

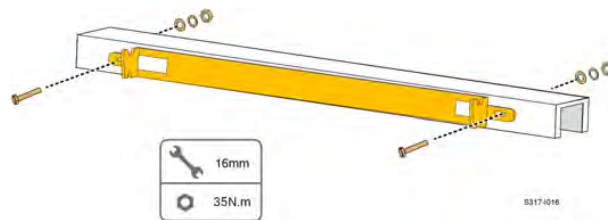

-- End

4.5.2 Wall-Mounted Installation

Tool preparation

Name	Specification
Maker	—
Level	-
Hammer drill	Bit: $\phi 12$
Wrench	Inner diameter: 16mm

Material preparation

Name	Quantity	Specification	Source
Expansion bolt	2	M10	Not included in the delivery scope

step 1 Place the mounting-bracket at the installation place, adjust the angle with a level, and mark the location of the drilled holes.

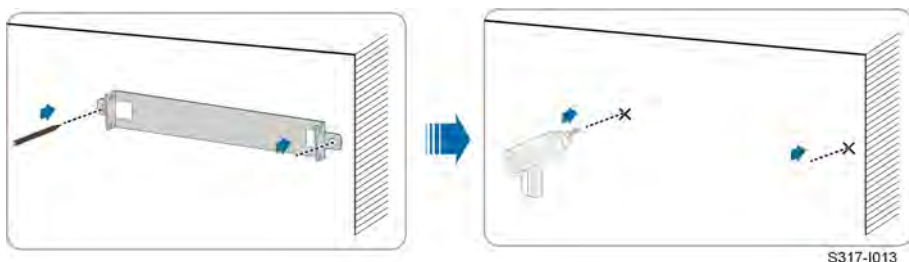

step 2 Drill holes with a hammer drill. Clean up the holes, stuff the expansion bolts into the holes, and fix them with a rubber mallet. Use a wrench to tighten the nut to fix the end of the bolt, take off the nut, spring washer and flat washer for spare.

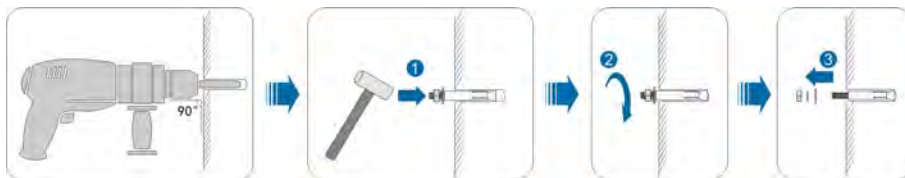

step 3 Secure the mounting-bracket with expansion bolts.

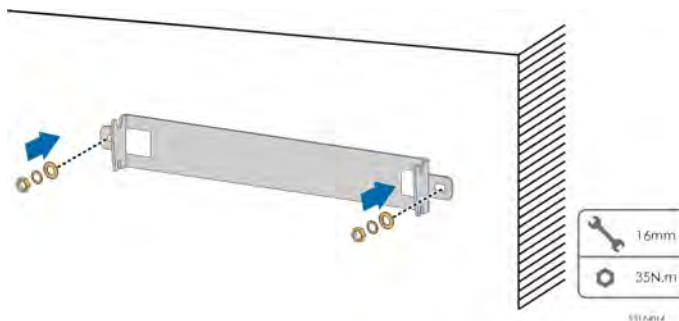

-- End

4.5.3 Pole Installation

Tool preparation

Name	Specification
Marker	—
Level	-
Hammer drill*	Bit: $\phi 12$
Wrench	Inner diameter: 16mm

*Check if tools of other specifications are needed according to the bolts of the matching clamps.

Material preparation

Name	Quantity	Specification	Source
Bolt assembly	2	M10	Included in the delivery scope
Bolt assembly	4	M10	Not included in the delivery scope
Steel u-channel	2	-	Not included in the delivery scope
Clamp	2	According to the pole specification	Not included in the delivery scope

step 1 Erect and stabilize the pole at the installation site.



Please skip this step if the inverter is to be installed on a concrete pole, PV bracket, etc. through pole-mounting.

step 2 Mark and drill holes in steel u-channels according to the dimensions shown in the figure below. Two steel u-channels should be spaced 180 mm - 260 mm apart.

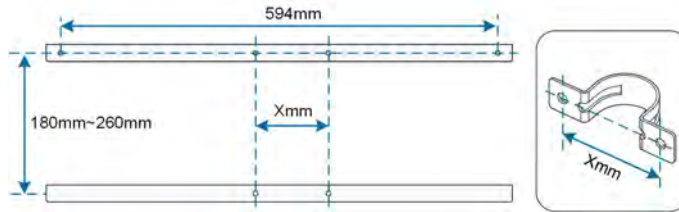

step 3 Secure the mounting-bracket to the steel u-channels with bolts.

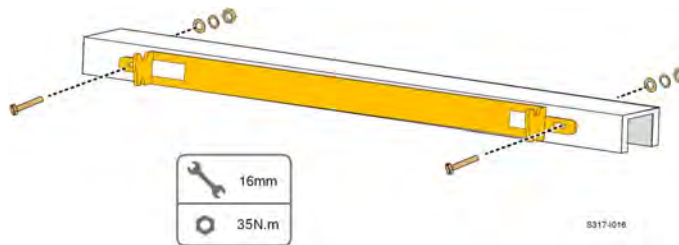

step 4 Secure the steel u-channels to the pole with bolts and clamps.

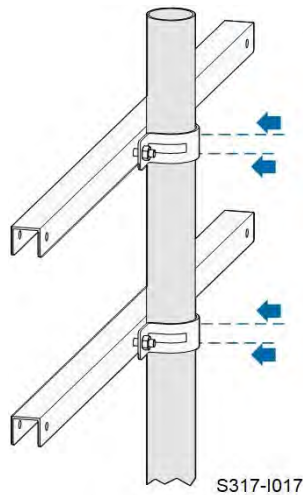

-- End

4.6 Installing the Inverter

Tool preparation

Name	Specification
Phillips screwdriver	M5

Material preparation

Name	Quantity	Specification	Source
Cross screw	2	M5×16	Included in the delivery scope

step 1 Take out the inverter from the packing case.

step 2 Lift the inverter onto the mounting-bracket and make sure the mounting ears fit well into the grooves of the mounting-bracket.

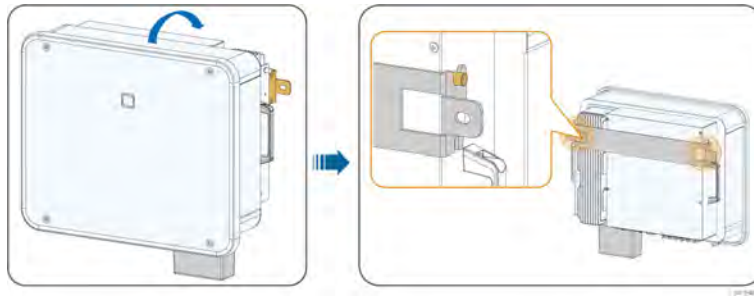

step 3 Fix the inverter with screws.

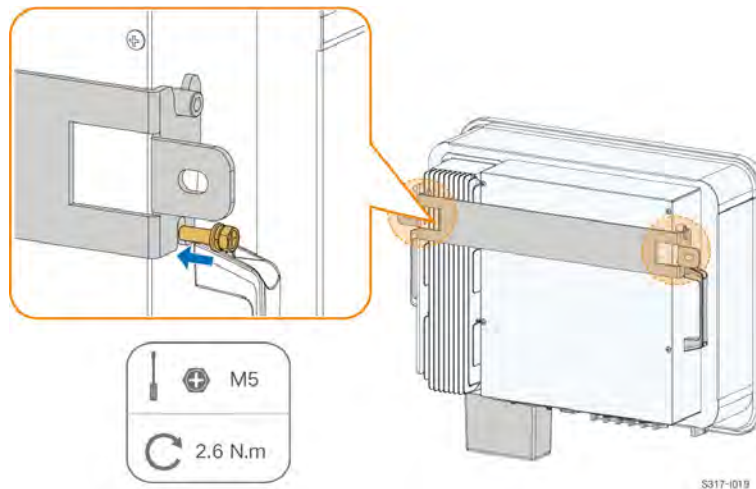

-- End

5 Electrical Connection

5.1 Safety Instructions

DANGER

The PV string will generate lethal high voltage when exposed to sunlight.

- Operators must wear proper personal protective equipment during electrical connections.
- Must ensure that cables are voltage-free with a measuring instrument before touching DC cables.
- Respect all safety instructions listed in relevant documents about PV strings.

DANGER

- Before electrical connections, please make sure that the inverter switch and all switches connected to the inverter are set to "OFF", otherwise electric shock may occur!
- Ensure that the inverter is undamaged and all cables are voltage free before performing electrical work.
- Do not close the AC circuit breaker until the electrical connection is complete.

WARNING

Damage to the product caused by incorrect wiring is not covered by the warranty.

- Electrical connection must be performed by professionals.
- Operators must wear proper personal protective equipment during electrical connections.
- All cables used in the PV generation system must be firmly attached, properly insulated, and adequately dimensioned.

NOTICE

All electrical connections must comply with local and national / regional electrical standards.

- Cables used by the user shall comply with the requirements of local laws and regulations.
- Only with the permission of the national / regional grid department, the inverter can be connected to the grid.

NOTICE

- All vacant terminals must be covered with waterproof covers to prevent affecting the protection rating.
- When the wiring is completed, seal the gap of cable inlet and outlet holes with fireproof / waterproof materials such as fireproof mud to prevent foreign matter or moisture from entering and affecting the long-term normal operation of the inverter.
- Comply with the safety instructions related to PV strings and the regulations related to the utility grid.



The cable colors in figures in this manual are for reference only. Please select cables according to local cable standards.

5.2 Terminal Description

All electrical terminals are located at the bottom of the inverter.

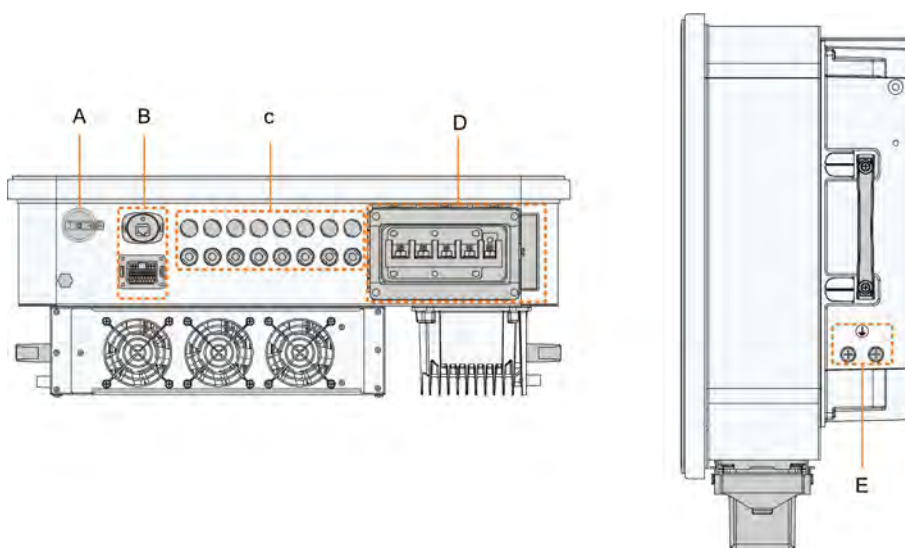

figure 5-1 Terminal Description

* The image shown here is for reference only. The actual product received may differ.

Item	Terminal	Mark	Note
A	DC Switch	DC SWITCH	Used to switch on and off the DC input.
B	Communication terminal	COM1	For communication module connection.
		COM2	DI, DRM, DO, RS485, Smart Energy Meter

Item	Terminal	Mark	Note
C	PV terminals	PV1,PV2, PV3, PV4, PV5, PV6	6 pairs of terminals (SG25/30/ 33CX-P2)
		PV1,PV2, PV3, PV4, PV5, PV6, PV7, PV8	8 pairs of terminals (SG36/40/ 50CX-P2)
D	AC wiring terminal	AC	Used for AC output cable connection.
E	External grounding terminal		Used for reliable grounding of the inverter 2, use at least one of them to ground the inverter.

table 5-1 The label of COM2 terminal

DI		DRM			DO	RS485		Meter
DI	DI	C	D4/8	D2/6	COM	B1	B1	B2
PGND	PGND	R	D3/7	D1/5	NO	A1	A1	A2

table 5-2 The label description of COM2 terminal

No.	Label	Description
1	DI	emergency stop dry contact
2	DRM	<ul style="list-style-type: none"> "AU"/"NZ": Demand response enabling device (DRED) "DE": Ripple Control Receiver (RCR)
3	DO	fault output dry contact
4	RS485 (A1, B1) ⁽¹⁾	<ul style="list-style-type: none"> Connect to the Logger, so as to implement data exchange with PC or other monitoring devices. Enable the communication between inverters in parallel.
5	Meter (A2, B2) ⁽¹⁾	Connect to the Smart Energy Meter.

(1) When the inverter is connected to a third-party monitoring device, please confirm which communication interface is used, and whether it will cause loss of certain functions of the inverter.

5.3 Electrical Connection Overview

Connecting the inverter to the PV system requires connecting the inverter to the protective grounding point, to the grid, and to the PV strings.

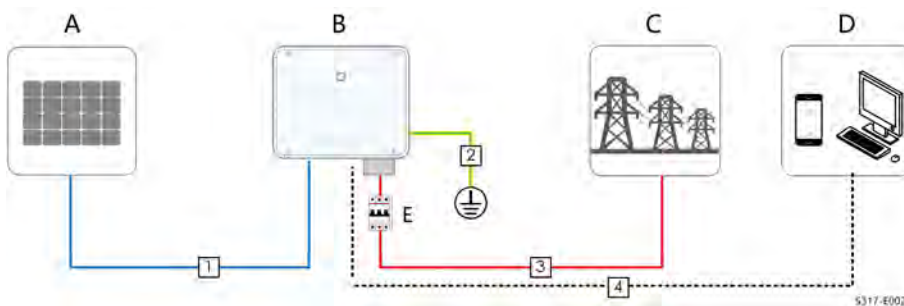

(A) PV string

(B) Inverter

(C) Grid

(D) Monitoring device

(E) AC circuit breaker

table 5-3 Cable Requirements

No.	Cable	Type	Specification	
			Cable Di- ameter (mm)	Cross-sectional Area(mm ²)
1	DC cable	Multi-core PV cable with a maximum with-stand voltage of 1100V	4.7 ~ 6.4	4 ~ 6
2	External grounding cable	Outdoor single-core copper wire	/	The same as that of the PE wire in the AC cable
3	AC cable	Outdoor four-core/five-core copper wire	18 ~ 38	L1,L2,L3,N wire : 16~35(SG25/30/33/36/40CX-P2) PE wire : 16**(SG25/30/33/36/40CX-P2)
		Outdoor four-core/five-core aluminum wire*		L1,L2,L3,N wire : 35~50(SG50CX-P2) PE wire : refer to"table 5-4 PE wire requirements"(SG50CX-P2) L1,L2,L3,N wire : 25~35(SG25/30/33/36/40CX-P2) PE wire : 16**(SG25/30/33/36/40CX-P2) L1,L2,L3,N wire : 35~50(SG50CX-P2) PE wire : refer to"table 5-4 PE wire requirements"(SG50CX-P2)

No.	Cable	Type	Specification	
			Cable Di- ameter (mm)	Cross-sectional Area(mm ²)
4	Communi- cation cable	Shielded twisted pair		0.5~1
		CAT 5E outdoor shielded network cable	5.3 ~ 7	/

*A copper to aluminum adapter terminal is required when an aluminum cable is used. For details, refer to "[Aluminium Cable Requirements](#)".

** The specifications are valid only when the phase wire and PE wire use the same material. If otherwise, ensure that the cross section of the PE wire produces a conductance equivalent to that of the 16mm² in the table.

table 5-4 PE wire requirements

PE wire cross section	Note
S/2 (S: Phase wire cross-section S)	The specifications are valid only when the phase wire and PE wire use the same material. If otherwise, ensure that the cross section of the PE wire produces a conductance equivalent to that of the wire specified in the table.

5.4 Crimp OT / DT terminal

Crimp OT / DT terminal

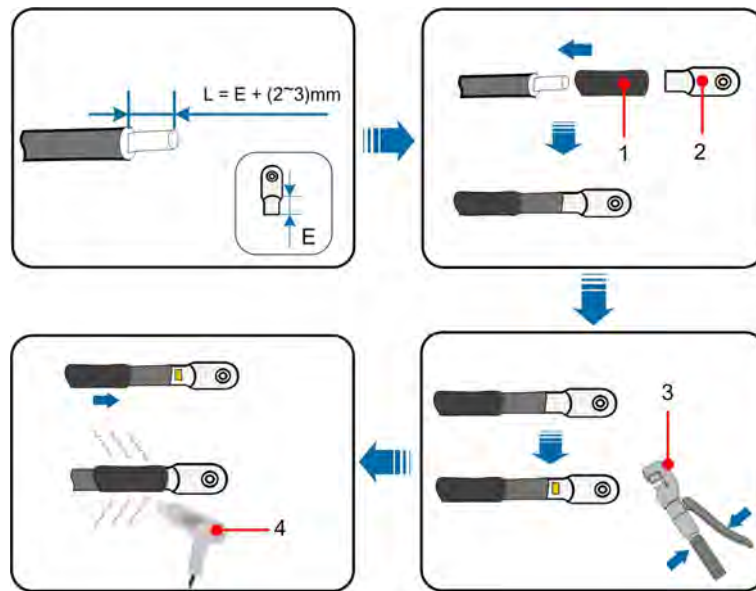

1. Heat shrink tubing

2. OT DT terminal

3. Hydraulic pliers

4. Heat gun

Aluminium Cable Requirements

If an aluminium cable is selected, use a copper to aluminium adapter terminal to avoid direct contact between the copper bar and the aluminium cable.

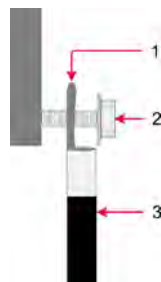

figure 5-2 Aluminium cable terminal connection sequence

1. Copper to Aluminium adapter terminal

2. Flange nut

3. Aluminium cable

NOTICE

Ensure that the selected terminal can directly contact with the copper bar. If there are any problems, contact the terminal manufacturer.

Ensure that the copper bar is not in direct contact with the aluminum wire. Otherwise, electrochemical corrosion may occur, impairing the reliability of electrical connection.

5.5 External Grounding Connection

⚠ DANGER

Electric shock!

- Make sure that the ground cable is connected reliably. Otherwise, it may cause electric shock.

⚠ WARNING

- Since the inverter is not equipped with a transformer, neither the negative electrode nor the positive electrode of the PV string can be grounded. Otherwise, the inverter will not operate normally.
- Connect the grounding terminal to the protective grounding point before AC cable connection, PV string connection, and communication cable connection.

⚠ WARNING

The external protective grounding terminal must meet at least one of the following requirements.

- The cross-sectional area of the AC side grounding cable is not less than 10 mm² for copper wire or 16 mm² for aluminum wire. It is recommended that both the external protective grounding terminal and the AC side grounding terminal be reliably grounded.
- If the cross-sectional area of the AC side grounding cable is less than 10 mm² for copper wire or 16 mm² for aluminum wire, ensure that both the external protective grounding terminal and the AC side grounding terminal are reliably grounded.

The grounding connection can be made by other means if they are in accordance with the local standards and regulations, and SUNGROW shall not be held liable for the possible consequences.

5.5.1 External Grounding Requirements

All non-current carrying metal parts and device enclosures in the PV power system should be grounded, for example, brackets of PV modules and inverter enclosure.

When there is only one inverter in the PV system, connect the external grounding cable to a nearby grounding point.

When there are multiple inverters in the PV system, connect grounding points of all inverters and the PV array frames to the equipotential cable (according to the onsite conditions) to implement an equipotential connection.

5.5.2 Connection Procedure

- step 1 Prepare the cable and OT / DT terminal, refer to "[Crimp OT / DT terminal](#)".
- step 2 Remove the screw on the grounding terminal and fasten the cable with a screwdriver.

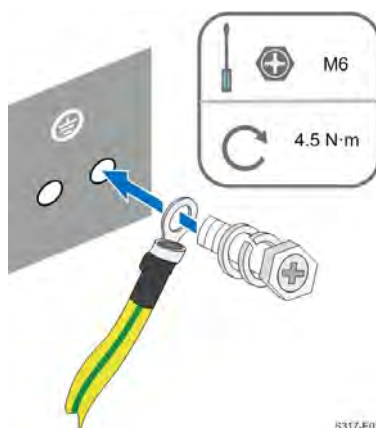

- step 3 Apply paint to the grounding terminal to ensure corrosion resistance.



The grounding screws have been anchored to the side of the inverter before delivery, and do not need to be prepared.

There are two grounding terminals. Use one of them to ground the inverter.

-- End

5.6 AC Cable Connection

5.6.1 AC Side Requirements



Only with the permission of the local grid department, the inverter can be connected to the grid.

Before connecting the inverter to the grid, ensure the grid voltage and frequency comply with requirements, for which, refer to "[Technical Data](#)". Otherwise, contact the electric power company for help.

AC Circuit Breaker

An independent circuit breaker or fuse should be installed on the output side of the inverter to ensure safe disconnection from the grid.

Inverter	Recommended rated voltage	Recommended rated current
SG25CX-P2	400V	63 A
SG30CX-P2	400V	63 A
SG33CX-P2	400V	80 A
SG36CX-P2	400V	80 A
SG40CX-P2	400V	100 A
SG50CX-P2	400V	125 A

WARNING

AC circuit breakers should be installed on the output side of the inverter and the grid side to ensure safe disconnection from the grid.

- **Determine whether an AC circuit breaker with greater overcurrent capacity is required based on actual conditions.**
- **Do not connect any local load between the inverter and the AC circuit breaker.**
- **Multiple inverters cannot share one AC circuit breaker.**

Residual Current Monitoring Device

With an integrated universal current-sensitive residual current monitoring unit included, the inverter will disconnect immediately from the mains power once a fault current with a value exceeding the limit is detected.

However if an external residual current device (RCD) (type A is recommended) is mandatory, the switch must be triggered at the residual current. RCD of other specifications can also be used according to local standard. The recommended residual current is as follows.

Inverter	Recommended residual current
SG25CX-P2	300 mA
SG30CX-P2	300 mA
SG33CX-P2	330 mA
SG36CX-P2	360 mA
SG40CX-P2	400 mA
SG50CX-P2	500 mA

Multiple Inverters in Parallel Connection

If multiple inverters are connected in parallel to the grid, ensure that the total number of parallel inverters does not exceed 30.

5.6.2 Requirements for OT/DT Terminal

OT / DT terminals (not included in the delivery scope) are required for fixing AC cables to the terminal block. Purchase the OT / DT terminals according to the following requirements.

OT / DT Terminals of Phase Wire

- Specification: M8

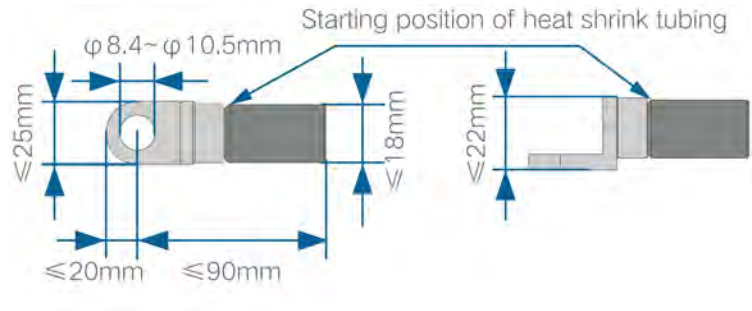

figure 5-3 Specifications of the Crimped OT/DT Terminal

OT / DT Terminal of PE Wire

- Specification: M8

5.6.3 Connection Procedure

- step 1 Disconnect the AC-side circuit breaker and prevent it from inadvertent reconnection.
- step 2 Take out the AC junction box and loosen the swivel nut. Remove the seals and select an appropriate one according to cable outer diameter. Lead the cable through the swivel nut, seal, and junction box successively.

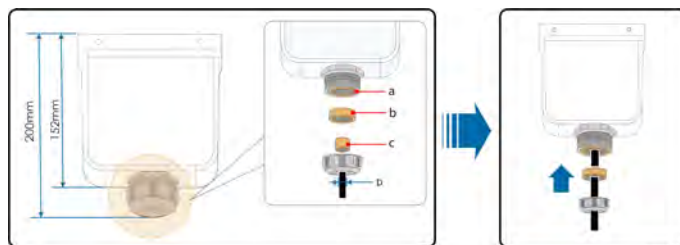

Outer diameter D(mm)	Seals
18 ~ 24	a+b+c
24 ~ 30	a+b
30 ~ 38	a

- step 3 Make the cable and crimp OT/DT terminal.

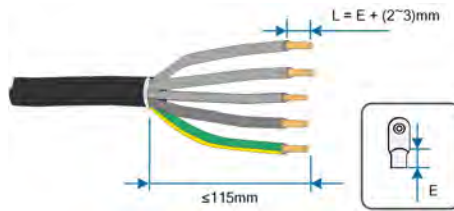

step 4 Remove the AC protective cap.

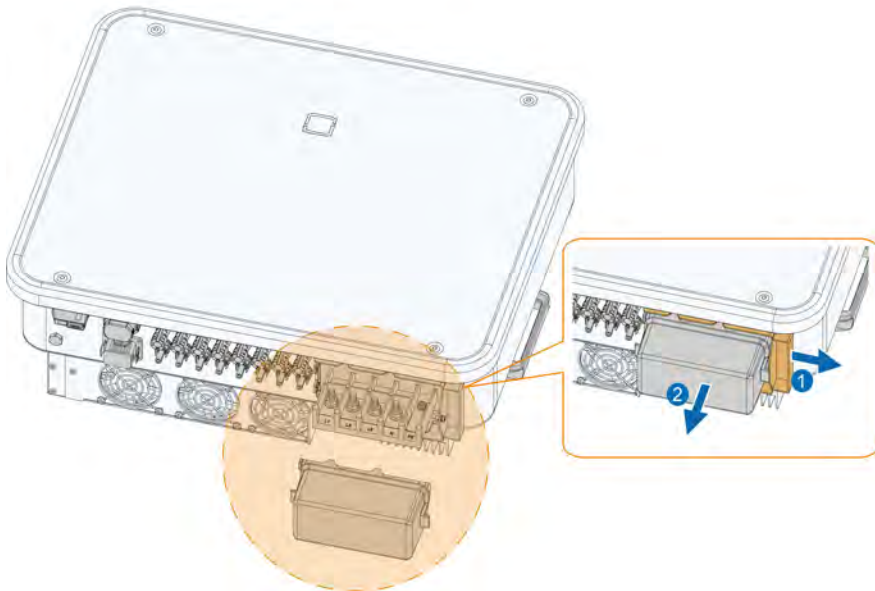

step 5 Secure the wires to corresponding terminals. Gently pull the cable backwards to ensure firm connection.

NOTICE

Observe the terminal layout on the block. Do not connect the phase wires to "PE" terminal or "N" terminal. Otherwise, unrecoverable damage to the inverter may follow.

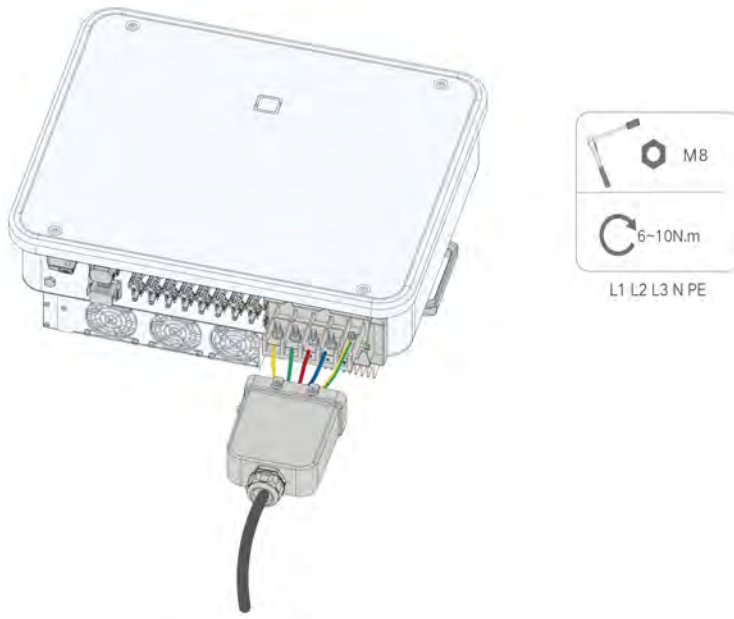

Ensure that the depth L of the socket used is not less than 18mm.

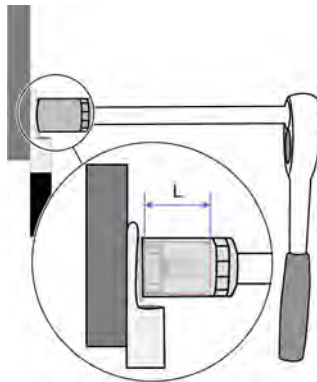

step 6 Secure the junction box.

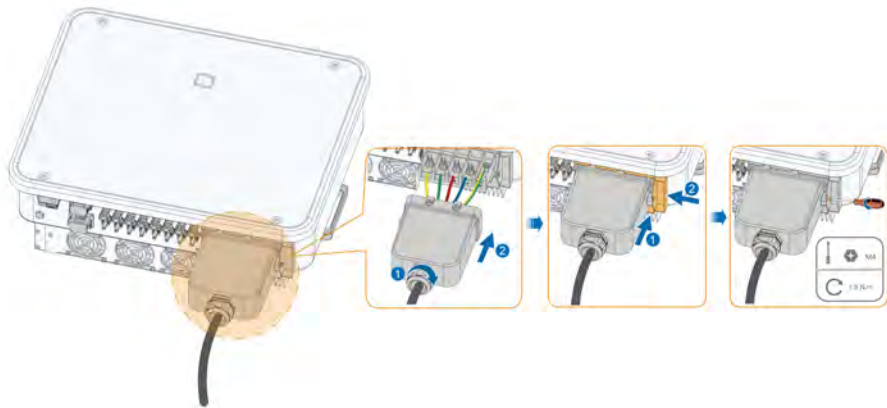
**NOTICE**

Ensure that the junction box is properly assembled. Failure to do so may affect the waterproof performance of the AC side, and the loss caused by this is not covered by the warranty.

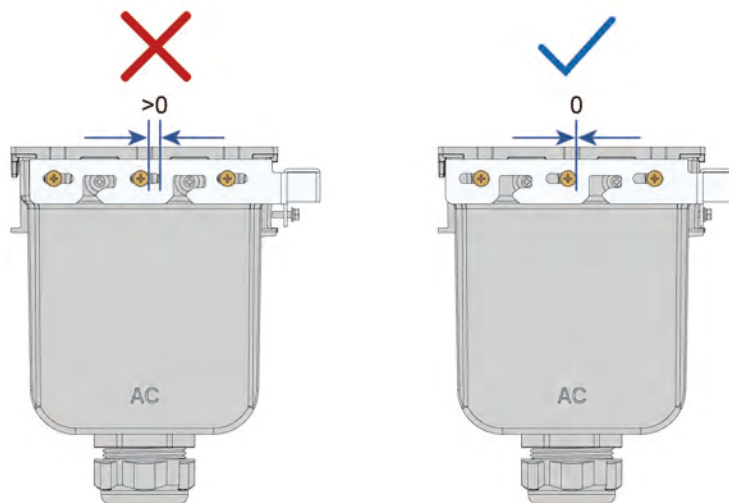

step 7 Gently pull the cable backwards to ensure firm connection, and fasten the swivel nut clockwise.

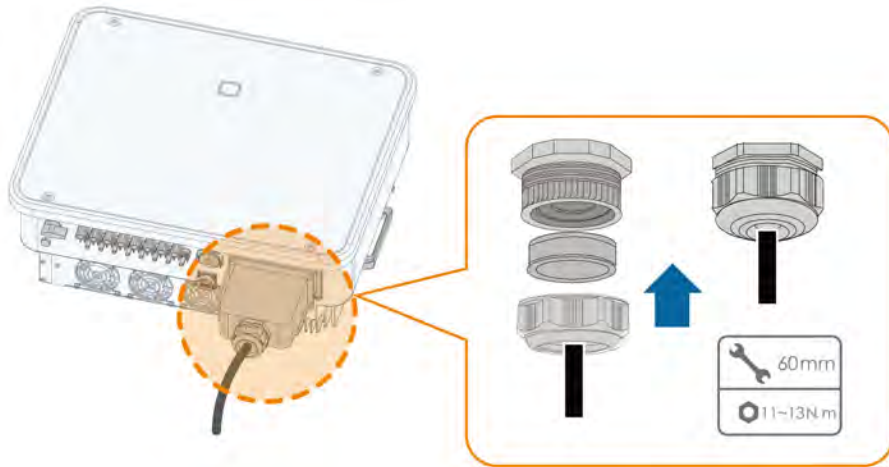

-- End

5.7 DC Cable Connection

⚠ DANGER

The PV string will generate lethal high voltage when exposed to sunlight.

- Respect all safety instructions listed in relevant documents about PV strings.

⚠ WARNING

- Make sure the PV array is well insulated to ground before connecting it to the inverter.
- Make sure the maximum DC voltage and the maximum short circuit current of any string never exceed inverter permitted values specified in "Technical Data".
- Check the positive and negative polarity of the PV strings, and connect the PV connectors to corresponding terminals only after ensuring polarity correctness.
- During the installation and operation of the inverter, please ensure that the positive or negative electrodes of PV strings do not short-circuit to the ground. Otherwise, an AC or DC short-circuit may occur, resulting in equipment damage. The damage caused by this is not covered by the warranty.
- Electric arc or contactor over-temperature may occur if the PV connectors are not firmly in place, and SUNGROW shall not be held liable for any damage caused.
- If the DC input cables are reversely connected or the positive and negative terminals of different MPPT are shorted to ground at the same time, while the DC switch is in the "ON" position, do not operate immediately. Otherwise, the inverter may be damaged. Please turn the DC switch to "OFF" and remove the DC connector to adjust the polarity of the strings when the string current is lower than 0.5 A.

NOTICE

The following requirements about PV string connection must be met. Otherwise, it may cause irreversible damage to the inverter, which is not covered by the warranty.

- **Mixed use of different brand or model of PV modules in one MPPT circuit, or PV modules of different orientation or angles in a string may not damage inverter but will cause system bad performance!**
- **The inverter enters standby state when the input voltage ranges between 1,000 V and 1,100 V. The inverter returns to running state once the voltage returns to the MPPT operating voltage range, namely, 160 V to 1,000 V.**

5.7.1 PV Input Configuration

- As shown in the figure below, the inverter is provided with multiple PV inputs, and each PV input is designed with an MPP tracker.
- Each PV input operates independently and has its own MPPT. In this way, string structures of each PV input may differ from each other, including PV module type, number of PV modules in each string, angle of tilt, and installation orientation.
- A maximum of two PV strings can be connected to an MPPT controller. For the best use of PV power, the type, quantity, tilt, and orientation of PV modules connected to the same MPPT shall be the same.

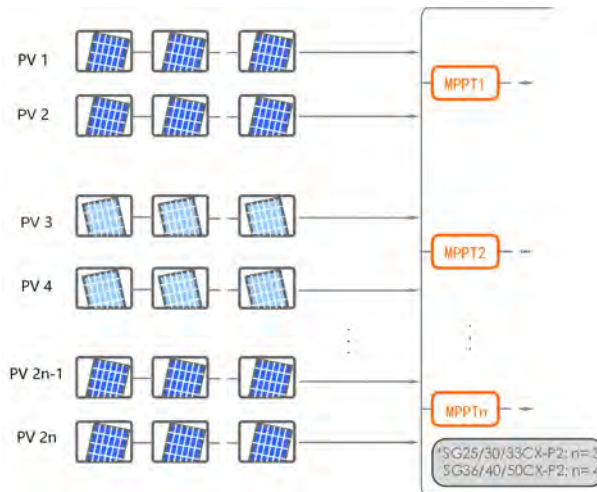

figure 5-4 PV Input Configuration

Prior to connecting the inverter to PV inputs, the specifications in the following table should be met:

Open-circuit Voltage Limit	Max. Current for Input Connector
1100 V	20 A

5.7.2 Assembling the PV Connectors

⚠ DANGER

High voltage may be present in the inverter!

- **Ensure all cables are voltage-free before performing electrical operations.**
- **Do not connect the AC circuit breaker before finishing electrical connection.**



SUNGROW provides corresponding PV connectors in the scope of delivery for quick connection of PV inputs. To ensure IP66 protection, use only the supplied connector or the connector with the same ingress of protection.

step 1 Strip the insulation from each DC cable by 8 mm ~ 10 mm.

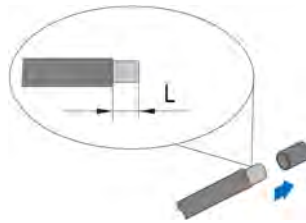

step 2 Assemble the cable ends with the crimping pliers.

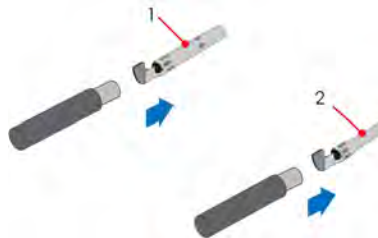

1: Positive crimp contact

2 : Negative crimp contact

step 3 Lead the cable through cable gland, and insert the crimp contact into the insulator until it snaps into place. Gently pull the cable backward to ensure firm connection.

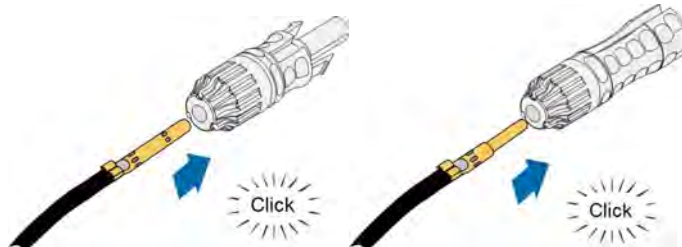

step 4 Tighten the cable gland and the insulator.

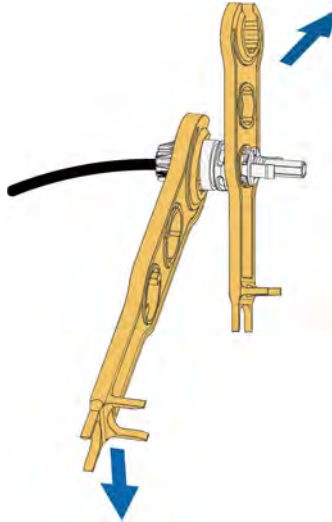

step 5 Check for polarity correctness.

NOTICE

If the PV polarity is reversed, the inverter will be in a fault or alarm state and will not operate normally.

-- End

5.7.3 Installing the PV Connector

step 1 Ensure that the DC switch is in "OFF" position. Otherwise, manually turn it to "OFF".

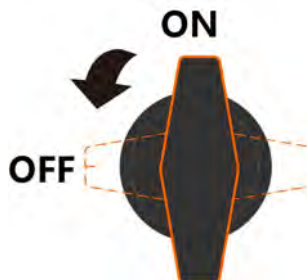

step 2 Check the cable connection of the PV string for polarity correctness and ensure that the open circuit voltage in any case does not exceed the inverter input limit of 1,100 V.



step 3 Connect the PV connectors to corresponding terminals until there is an audible click.

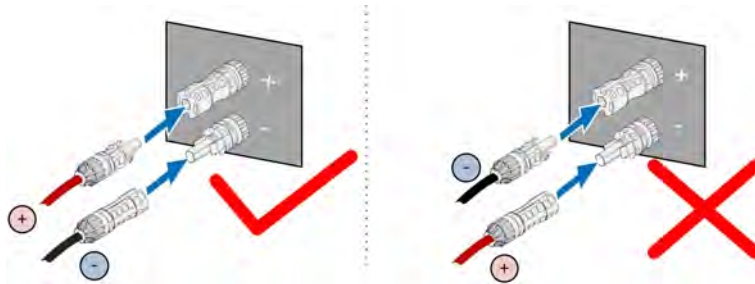

step 4 Follow the foregoing steps to connect PV connectors of other PV strings.

step 5 Seal any unused PV terminal with a terminal cap.

-- End

5.8 Communication Connection

5.8.1 Wireless Communication Module Connection (optional)

Install the wireless communication module to the communication interface with a silk screen of COM1 at the bottom of the inverter.

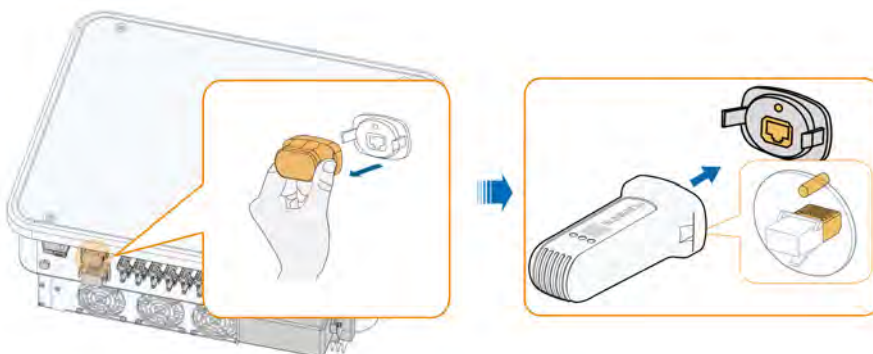

*The image shown here is for reference only. The actual product you receive may differ.

NOTICE

Once the communication module is in use, do not connect the inverter to a 3rd party data logger at the same time via RS485.



For details on module installation and configuration, refer to the manual delivered together with the module.

5.8.2 WiNet-S Connection (optional)

The WiNet-S module supports Ethernet communication and WLAN communication. It is not recommended to use both communication methods at the same time.

For details, see the quick guide for the WiNet-S module. Scan the following QR code for the quick guide.



5.8.2.1 Ethernet Communication

step 1 **(Optional)** Strip the insulation layer of the communication cable with an Ethernet wire stripper, and lead the corresponding signal cables out. Insert the stripped communication cable into the RJ45 plug in the correct order, and crimp it with a crimper.

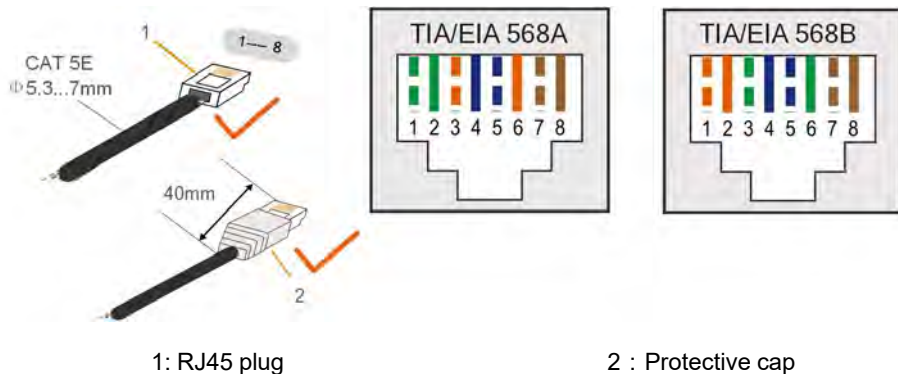

Skip this step if a standard network cable with RJ45 plug is prepared.

step 2 Unscrew the swivel nut from the communication module and take out the inner sealing ring.

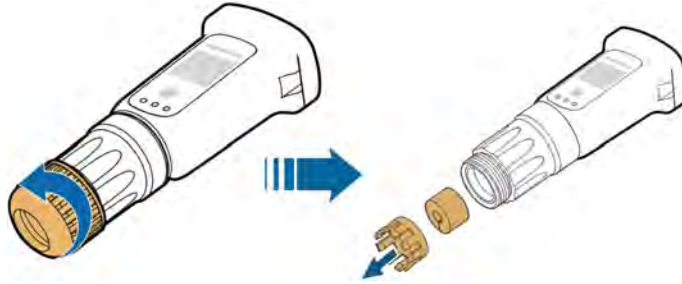

step 3 Unscrew the housing from the communication module.

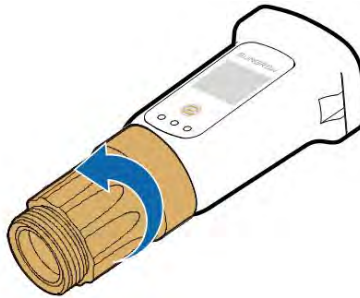

step 4 Thread the network cable through the swivel nut and gasket. Afterwards, route the cable into the opening of the sealing. Finally, insert the cable through the housing.

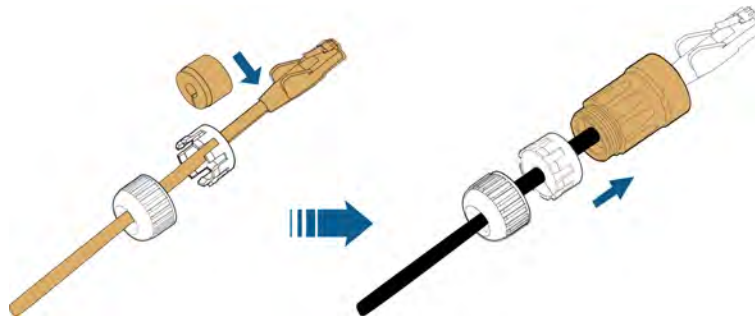

step 5 Insert the RJ45 plug into the front plug connector until there is an audible click and tighten the housing. Install the gasket and fasten the swivel nut.

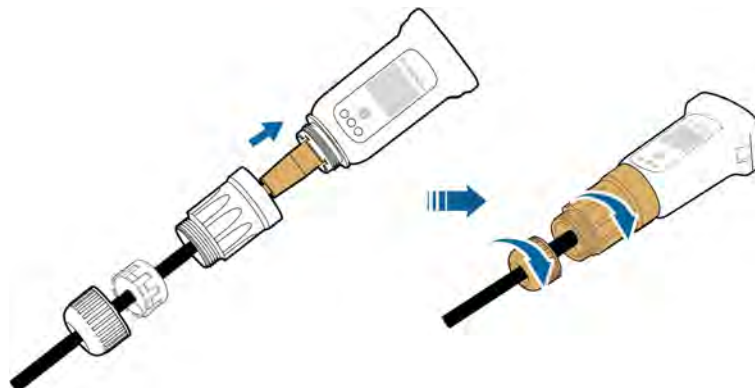

step 6 Remove the waterproof lid from the **COM1** terminal and install WiNet-S.

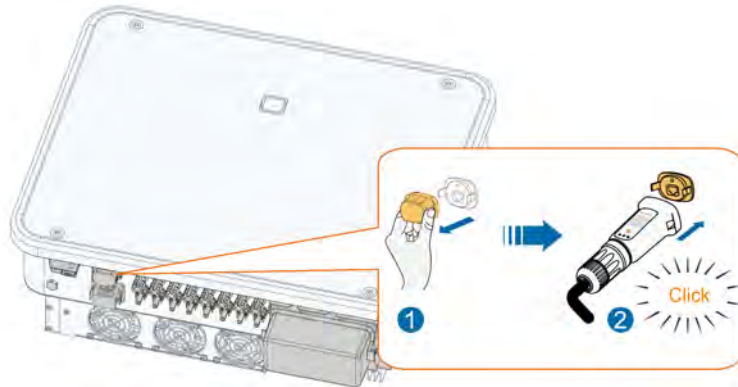

step 7 Slightly shake it by hand to determine whether it is installed firmly.

-- End

5.8.2.2 WLAN Communication

step 1 Remove the waterproof lid from the **COM1** terminal.

step 2 Install the module. Slightly shake it by hand to determine whether it is installed firmly, as shown below.

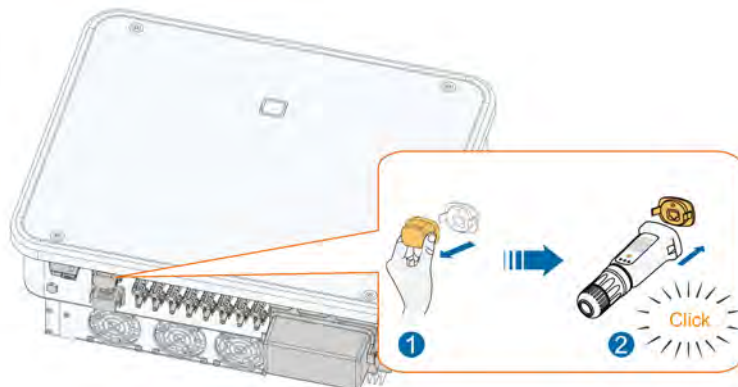

step 3 Refer to the guide delivered with the module for the set-up.

-- End

5.8.3 RS485 Connection

Where there is only one inverter, the RS485 can be connected to an external device for the communication, as shown in the following figure.

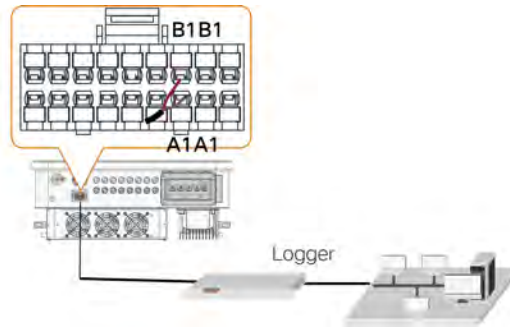

In case of multiple inverters, all the inverters can be connected via RS485 cables in the daisy chain manner, as shown in the following figure.

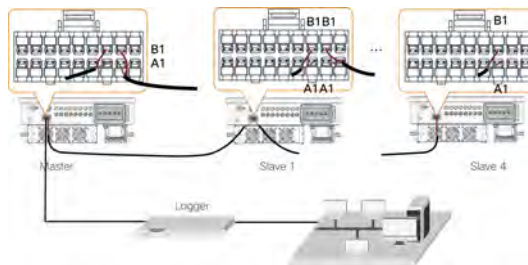

5.8.3.1 Assembling the COM Connector

step 1 Unscrew the swivel nut from the connector.

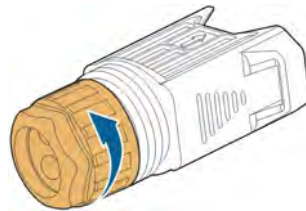

step 2 Take out the terminal block.

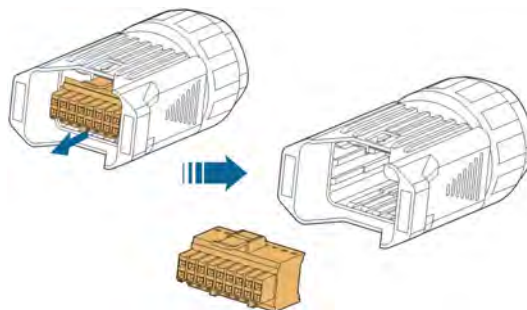

step 3 Remove the seal and lead the cable through the cable gland.

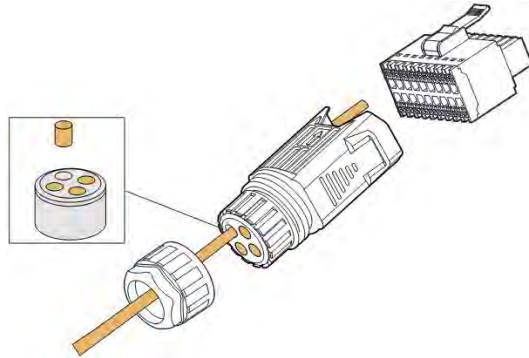

step 4 Remove the cable jacket and strip the wire insulation.



step 5 Plug the wires into the **RS485** terminal according to the labels on the bottom of the inverter.

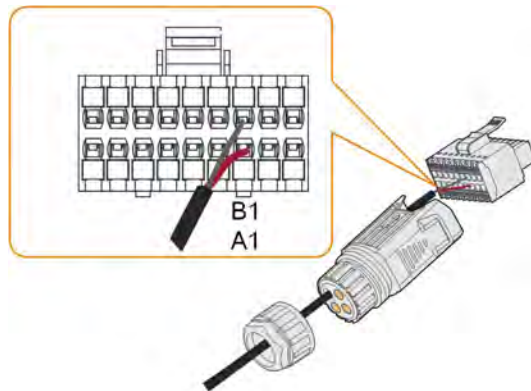

step 6 Pull the wires outward to check whether they are firmly installed.

step 7 Insert the terminal block into the connector until it snaps into place with an audible click.

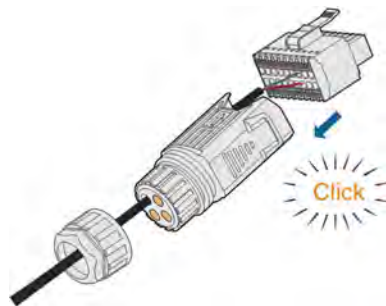

step 8 Fasten the swivel nut.

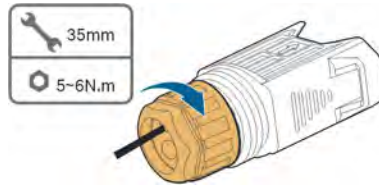

-- End

5.8.3.2 Installing the COM Connector

step 1 Remove the waterproof lid from the **COM** terminal.



step 2 Insert the COM connector into **COM** terminal on the bottom of the inverter until there is an audible click.



-- End

5.8.4 Smart Energy Meter Connection

The inverter is equipped with the feed-in power limit function, so as to meet the requirements of some national standards or grid standards for the output power at the grid connection point. For the setting of feed-in power limit, refer to the section ["7.3.2 Login Procedure"](#)

Contact SUNGROW to ensure that the Smart Energy Meter model is available locally.



This section mainly describes the cable connections on the inverter side. Refer to the quick guide delivered with the Smart Energy Meter for the connections on the meter side.

Procedure

For detailed connection description of the Smart Energy Meter cable, refer to the section "[5.8.3 RS485 Connection](#)". Plug the wires into the **Meter** terminal according the labels on the bottom of the inverter.

5.8.5 Dry Contact Connection

NOTICE

Dry contact cables require a cross section of 1 mm² to 1.5 mm².
The connection procedure of the dry contact is the same as that of the RS485 terminal block.

5.8.5.1 Dry Contact Function

Connection method of the dry contacts is similar to that of the RS485 terminal block.

DI terminal (emergency stop dry contact): the dry contact can be configured to be an emergency stop contact.

When the DI contact and PGND contact are shorted by external controlled switch (The external switch can be configured as normally open contact or normally closed contact), the inverter will immediately stop.

NS terminal: NS Protection is used for German market currently. For plant sized more than 30kVA, inverter NS Protection terminals could be used in daisy chain to external NS Protection Relay to realize emergency stop when NS Protection Relay change its dry contact status due to the grid abnormal running status.

NS Protection (including Passive Valid) can be set. When NS Protection is enabled on the iSolarCloud, the inverters will operate normally when DI contact and PGND contact are shorted by external controlled switch, and the inverters will emergently stop when DI contact and PGND contact are disconnected.



The dry contacts only support passive switch signal input.

When wiring DI dry contacts, ensure that the maximum wiring distance meet the requirements in "[10.2 Wiring Distance of DI Dry Contact](#)".

DO terminal (fault output dry contact): The relay can be set to output fault alarms, and user can configure it to be a normally open contact (COM & NO).

Use LED indicators or other equipment to indicate whether the inverter is in the faulty state.

Devices connected to the relay should comply with related requirements:

AC-Side Requirements	DC-Side Requirements
Max. voltage: 250 Vac	Max. voltage: 30Vdc
Max. current: 5A	Max. current: 5A

5.8.5.2 Wiring Procedure

For detailed connection description of the DI/DO cable, refer to the section "[5.8.3 RS485 Connection](#)". Plug the wires into the **DI/DO** terminal according the labels on the bottom of the inverter.

5.8.6 DRM Connection

DRM and Ripple Control support only one function at the same time.

DRM

In Australia and New Zealand, the inverter supports the demand response modes as specified in the standard AS/NZS 4777.

The following figure shows the wiring between the inverter and the external DRED.

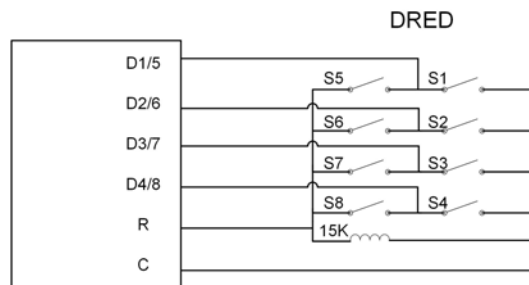

table 5-5 Method of Asserting DRM

Mode	Asserted by Shorting Terminals on Inverter	Switch Operation on External DRED
DRM0	R & C	Close S1 and S5



Enable the DRM function through the iSolarCloud APP. If there are any problems, contact your distributor first. If the problem persists, contact SUNGROW.

The DRM function is only applicable to devices for Australia and New Zealand.

Ripple Control

In Germany, the grid company uses the Ripple Control Receiver to convert the grid dispatching signal and send it as a dry contact signal.

Wiring of the ripple control receiver dry contact cables is shown in the figure below:

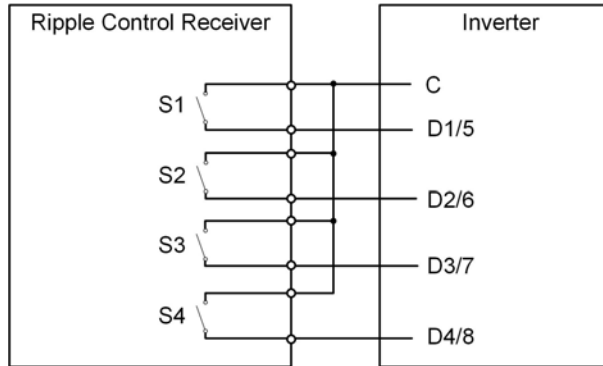
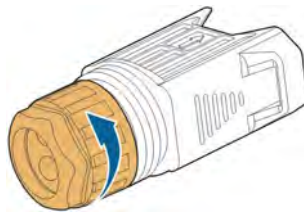

table 5-6 Method of Asserting DI Mode

S1	S2	S3	S4	Switch Operation on External RCR	Output power (in % of the Max. AC output power)
0	0	0	0	None	100%
1	0	0	0	Close S1	100%
0	1	0	0	Close S2	60%
0	0	1	0	Close S3	30%
1	1	0	0	Close S1 and S2	0% (disconnect from grid)

5.8.6.1 Assembling the COM Connector

step 1 Unscrew the swivel nut from the connector.



step 2 Take out the terminal block.

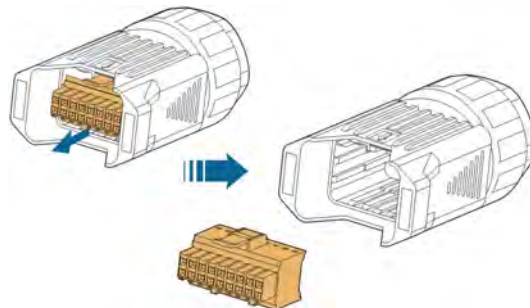

step 3 Remove the seal and lead the cable through the cable gland.

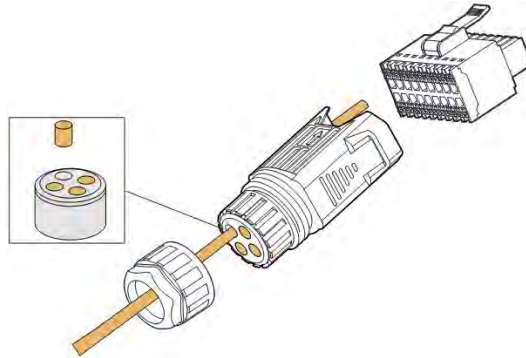

step 4 Remove the cable jacket by 7 mm–10 mm.

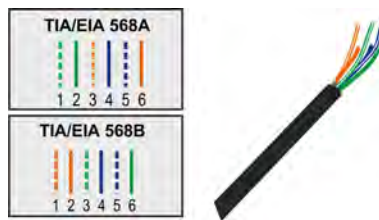

step 5 Plug the wires into the corresponding terminal according the labels on the bottom of the inverter.

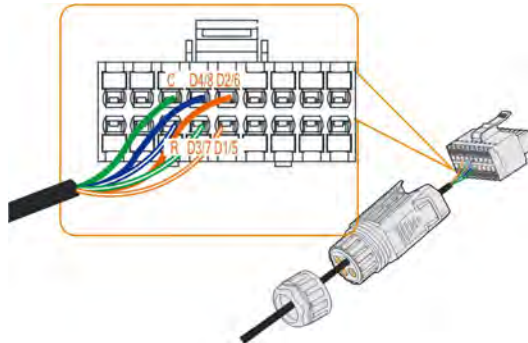

step 6 Pull the wires outward to check whether they are firmly installed.

step 7 Insert the terminal block into the connector until it snaps into place with an audible click.

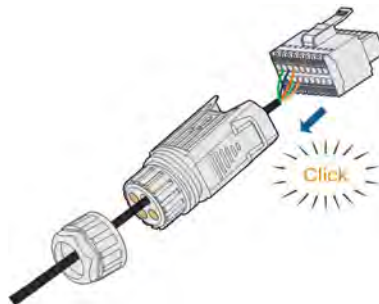

step 8 Fasten the swivel nut.

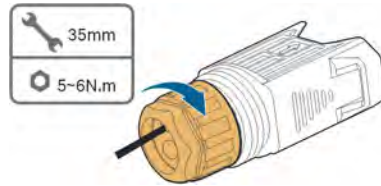

-- End

5.8.6.2 Installing the COM Connector

step 1 Remove the waterproof lid from the **COM** terminal.



step 2 Insert the COM connector into **COM** terminal on the bottom of the inverter until there is an audible click.



step 3 Pull cables outwards to confirm whether they are fastened firmly.

step 4 Connect the other end to the DRED / Ripple Control Receiver device.

-- End

6 Commissioning

6.1 Inspection before Commissioning

Check the following items before starting the inverter:

- All equipment has been reliably installed.
- DC switch(es) and AC circuit breaker are in the "OFF" position.
- The ground cable is properly and reliably connected.
- The AC cable is properly and reliably connected.
- The DC cable is properly and reliably connected.
- The communication cable is properly and reliably connected.
- The vacant terminals are sealed.
- No foreign items, such as tools, are left on the top of the machine or in the junction box (if there is).
- The AC circuit breaker is selected in accordance with the requirements of this manual and local standards.
- All warning signs & labels are intact and legible.

6.2 Commissioning Procedure

If all of the items mentioned above meet the requirements, proceed as follows to start up the inverter for the first time.

step 1 Rotate the DC switch of the inverter to the "ON" position, the indicator blinks blue slowly.

NOTICE

The indicator is red if there is no power supply from the grid. Report the grid power failure (the fault information can be viewed on the iSolarCloud App, see "Records" for details). The fault is automatically cleared when the AC circuit breaker between the inverter and the grid is closed.

step 2 Close the AC circuit breaker between the inverter and the grid.

step 3 Install the iSolarCloud App, see ["7.2 Installing the App"](#) for details.

step 4 Set initial protection parameters via the iSolarCloud App when the inverter is connected to the grid for the first time (see Step 4 in ["7.3.2 Login Procedure"](#) for details). If the irradiation and grid conditions meet requirements, the inverter normally operates.

step 5 The home page is automatically displayed when the initialization is completed. The indicator is steady blue, and the inverter is in grid-connected operation.

-- End

7 iSolarCloud App

7.1 Brief Introduction

The iSolarCloud App can establish communication connection to the inverter via the Bluetooth, thereby achieving near-end maintenance on the inverter. Users can use the App to view basic information, alarms, and events, set parameters, or download logs, etc.



Screenshots in this manual are based on the Android system V2.1.6 , and the actual interfaces may differ.

7.2 Installing the App

Method 1

Download and install the App through the following application stores:

- MyApp (Android, mainland China users)
- Google Play (Android, users other than mainland China ones)
- App Store (iOS)

Method 2

Scan the following QR code to download and install the App according to the prompt information.



The App icon appears on the home screen after installation.



7.3 Login

7.3.1 Requirements

The following requirements should be met:

- The AC or DC side of the inverter is powered-on.
- The mobile phone is within 5 meters away from the inverter and there are no obstructions in between.
- The Bluetooth function of the mobile phone is enabled.



The inverter can only pair with one phone at a time through Bluetooth.

7.3.2 Login Procedure

- step 1 Open the App to enter the login page, tap **Local Access** at the bottom of the page to go to the next page.
- step 2 Scan the QR code on the side of the inverter for Bluetooth connection. Or tap **MANUAL CONNECTION** at the bottom of the interface and select **Others**, the Bluetooth search interface will automatically appear. Select the inverter to be connected according to the serial number on the nameplate on the side of the inverter, or tap  to scan the QR code on the side of the inverter for Bluetooth connection. The connection is successfully established if the LED indicator blinks blue.

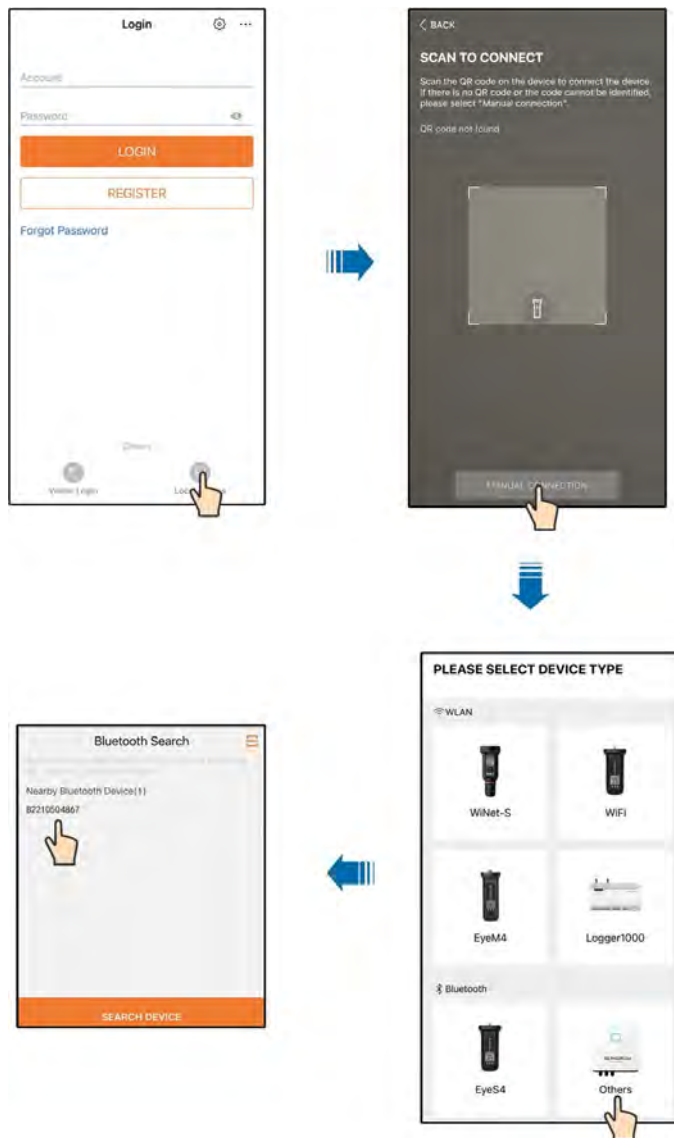

figure 7-1 Bluetooth Connection

step 3 Enter the identity verification screen after the Bluetooth connection is established.

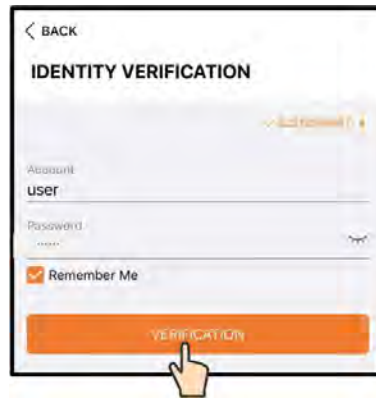

figure 7-2 Login



The Account is “user” , and the initial password is "pw1111" or "111111" which should be changed for the consideration of account security.

To set inverter parameters related to grid protection and grid support, contact your distributor to obtain the advanced account and corresponding password. If the distributor is unable to provide the required information, contact SUNGROW.

step 4 If the inverter is not initialized, you will enter the quick setting screen of initializing protection parameter.

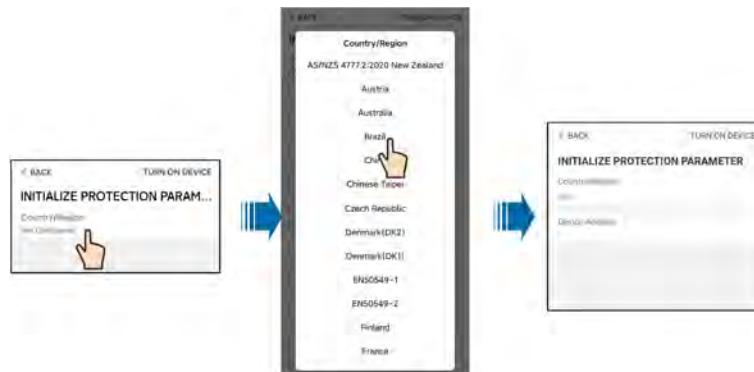

figure 7-3 Initialization Protection Parameter

NOTICE

The Country/Region must be set to the country where the inverter is installed at. Otherwise, the inverter may report errors.

step 5 When the country is set to Australia, additionally set the applicable network service provider and then the grid type. Tap **Power Company** to select the correct power company.

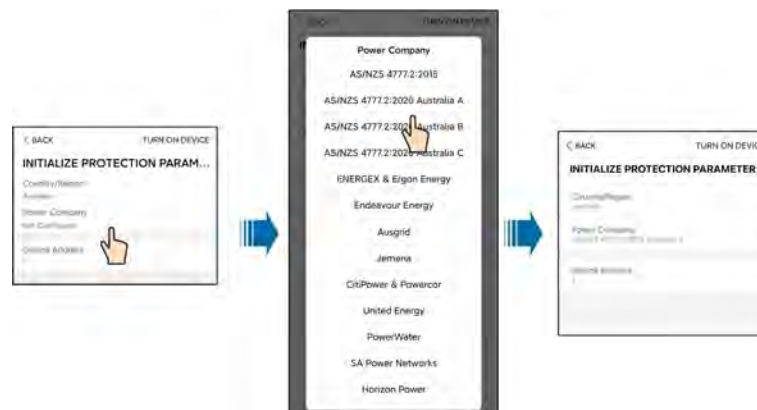

figure 7-4 Initialization Power Company

The image shown here is for reference only. Refer to the actual interface for the supported network service providers.

table 7-1 Power Company Information

Network Service Provider	Grid Type
AS/NZS 4777.2:2015	/
AS/NZS 4777.2:2020 Australia A	/
AS/NZS 4777.2:2020 Australia B	/
AS/NZS 4777.2:2020 Australia C	/
ENERGEN & Ergon Energy	<ul style="list-style-type: none"> STNW1170: single phase < 10 kVA & three phase < 30 kVA STNW1174 :30 kVA < PN ≤ 1500 kVA
Endeavour Energy	MDI 0043
Ausgrid	NS194
Jemena	<ul style="list-style-type: none"> ≤ 10kVA per phase (or 30 kVA per three phase) ELE GU 0014: 30-200kVA
CitiPower & Powercor	<ul style="list-style-type: none"> ≤ 5 kVA for single-phase & 30 kVA for three-phase > 30 kVA three-phase
United Energy	<ul style="list-style-type: none"> UE-ST-2008.1: ≤ 10 kW for single-phase & 30 kW for three-phase UE-ST-2008.2: > 30 kVA three-phase
PowerWater	Embedded Generation Notice Photovoltaic Systems:2020

Network Service Provider	Grid Type
SA Power Networks	<ul style="list-style-type: none"> • TS129-2019: < 10 kW for single-phase & 30 kW for three-phase • TS130-2017: > 30 kW & ≤ 200 kW • TS131-2018: > 200 kW
Horizon Power	<ul style="list-style-type: none"> • HPC-9DJ-13-0001-2019: ≤ 10 kVA for single-phase & 30 kVA for three-phase • HPC-9DJ-13-0002-2019: > 30 kVA & ≤1 MVA
westernpower	EDM # 33612889-2019
AusNet Services	Basic Micro Embedded Generation:2020

For compliance with AS/NZS 4777.2:2020, please select from Australia A/B/C. Please contact your electricity grid operator for which region to use.

- step 6 The function of the feed-in limitation is to control the amount of power injected in the grid by the plant. In some situations, this function is also called as **Export limitation** or **Zero export**. The feed-in limitation function requires the using of Smart Energy Meter. Without the Smart Energy Meter, the feed-in limitation function will be unavailable.



table 7-2 Description of feed-in limitation parameters

Parameter	Default value	Range
Feed-in Limitation	Off	On / Off
Feed-in Limitation Value	0.00kW	0 ~ Max. AC output power
Feed-in Limitation Ratio	0.0%	0 ~ 100%×Active Overload Rate*

*The active overload rate of SG30CX-P2 in Germany, Belgium, Austria, Ukraine, and Denmark is 1, and in other regions is 1.1. The active overload rate of SG25/33/36/40/50CX-P2 is 1.1.

- step 7 After finishing the settings, tap **TUNR ON DEVICE** at the upper right corner and the device will be initialized. The App will send start instructions and the device will start and operate.
- step 8 If the inverter is initialized, the App automatically turns to its home page.

-- End

7.4 Function Overview

The App provides parameter viewing and setting functions, as shown in the following figure.

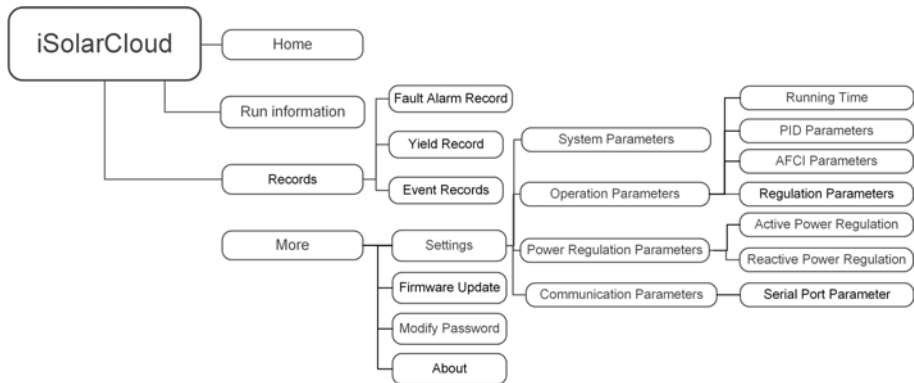

figure 7-5 App function tree map

7.5 Home page

After login, the home page is as follows:



figure 7-6 Home Page

table 7-3 Home Page Description

No.	Designation	Description
1	Date and time	System date and time of the inverter.
2	Inverter state	Present operation state of the inverter. For details, refer to "table 7-4 Description of Inverter State".
3	PID state	Present state of the PID. For details, refer to "table 7-5 Description of PID State".
4	Power flow chart	Displays the PV power generation power, feed-in power, etc. The line with an arrow indicates energy flow between connected devices, and the arrow pointing indicates energy flow direction.
5	Power generation	Today power yield and accumulative power yield of the inverter.
6	Real-time power	Output power of the inverter.
7	Power curve	Shows the change of power between 5 am and 23 pm every day (Each point on the curve represents the percentage of present inverter power to rated power).
8	Navigation bar	Including "Home", "Run-info", "His-record", and "More".

table 7-4 Description of Inverter State

State	Description
Run	After being energized, the inverter tracks the PV arrays' maximum power point (MPP) and converts the DC power into AC power. This is the normal operation mode.
Stop	The inverter is stopped.
Key-stop	The inverter will stop operation by manually "stop" via app. In this way, inverter internal DSP stops. To restart the inverter, manually start via app.
Standby	The inverter enters standby mode when DC side input is insufficient. In this mode the inverter will wait within the standby duration.
Initial standby	The inverter is in the initial power-on standby state.
Starting	The inverter is initializing and synchronizing with the grid.
Warning	Warning information is detected.
Derating running	The inverter derates actively due to environmental factors such as temperature or altitude
Scheduling running	The inverter runs according to the scheduling instructions received from the monitoring background
Fault	If a fault occurs, the inverter will automatically stop operation, and disconnect the AC relay. The fault information will be displayed in the app. Once the fault is removed in recovery time, the inverter will automatically resume running.

table 7-5 Description of PID State

State	Description
PID recovery running	The inverters perform PID recovery actively.
PID abnormality	It is detected that the ISO impedance is abnormal or the PID cannot work normally after the PID function being enabled.

If the inverter is running abnormally, the alarm or fault icon  will be displayed in the lower right corner of the inverter icon in power flow chart. The user can tap this icon to enter the alarm or fault screen to view detailed information and corrective measures.

7.6 Run Information

Tap **Run Information** on the navigation bar to enter the screen showing running information, slide the screen upwards to view all detailed information.

Run information includes PV information, inverter information, input and output information, etc.

table 7-6 Run Information

Classification	Parameter	Description
PV Information	String n Voltage	The input voltage of the n th string
	String n current	The input current of the n th string
Inverter Information	Total On-grid Running Time	/
	Daily On-grid Running Time	/
	Negative Voltage to Ground	Inverter DC side negative to ground voltage value
	Bus Voltage	Voltage between the positive and negative poles of the DC side of the inverter
	Internal Air Temperature	/
	Array Insulation Resistance	Insulation resistance value of the input side to the protection ground
	Country Information	/
	Power Limitation Mode	/
	Reactive Power Mode	/
	Input	Total DC Power
MPPT x Voltage		The input voltage of the x th MPPT
MPPT x Current		The input current of the x th MPPT
Output	Daily Yield	/
	Monthly Yield	/
	Annual Yield	/
	Total Active Power	Current active power value of the inverter
	Total Reactive Power	Current reactive power value of the inverter
	Total Apparent Power	Current apparent power value of the inverter
	Total Power Factor	Power factor of the AC side of the inverter
	Gird Frequency	Frequency of the AC side of the inverter
	A-B Line Voltage	Line Voltage
	B-C Line Voltage	
	C-A Line Voltage	
	Phase A Current	Phase Current
	Phase B Current	

Classification	Parameter	Description
	Phase C Current	

7.7 Records

Tap **Records** on the navigation bar to enter the screen showing event records, as shown in the following figure.



figure 7-7 Records

Fault Alarm Record

Tap **Fault Alarm Record** to enter the screen, as shown in the following figure.



figure 7-8 Fault Alarm Record



Click  to select a time segment and view corresponding records.
The inverter can record up to 400 latest entries.

Select one of the records in the list and click the record, to view the detailed fault info as shown in following figure.

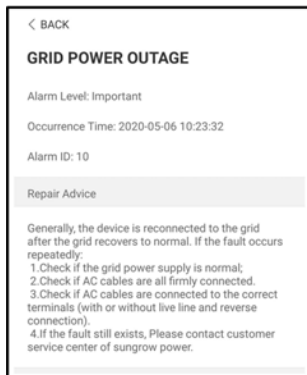

figure 7-9 Detailed Fault Alarm Information

Yield Record

Tap **Yield Record** to enter the screen showing daily power generation , as shown in the following figure.

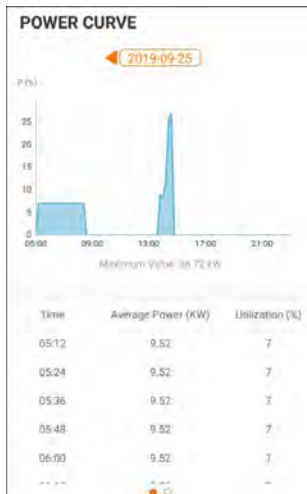

figure 7-10 Power Curve

The App displays power generation records in a variety of forms, including daily power generation graph, monthly power generation histogram, annual power generation histogram and total power generation histogram.

table 7-7 Explanation of Power Yields Records

Parameter	Description
Power curve	Shows the power output from 5 am to 23 pm in a single day. Each point on the curve is the percentage of present power to rated power.
Daily energy histogram	Shows the power output every day in the present month.

Parameter	Description
Monthly energy histogram	Shows the power output every month in a year.
Annual energy histogram	Shows the power output every year.

Tap the time bar on the top of the screen to select a time segment and view the corresponding power curve.

Swipe left to check the power yields histogram.

Event Record

Tap **Event Record** to view event record list.



Click  to select a time segment and view corresponding records.

The inverter can at most record the latest 400 events.

7.8 More

Tap **More** on the navigation bar to enter the corresponding screen, as shown in the following figure.

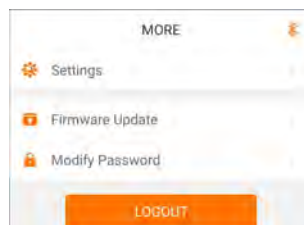

figure 7-11 More

7.8.1 System Parameters

Tap **Settings**→**System Parameters** to enter the corresponding screen, as shown in the following figure.



figure 7-12 System Parameters

* The image shown here is for reference only.

Boot/Shutdown

Tap **Boot/Shutdown** to send the boot/shutdown instruction to the inverter.

Date Setting/Time Setting

The correct system time is very important. Wrong system time will directly affect the data logging and power generation value. The clock is in 24-hour format.

Software Version

Version information of the current firmware.

7.8.2 Operation Parameters

Running Time

Tap **Settings**→**Operation Parameters**→**Running Time** to enter the corresponding screen, on which you can set "Running Time".

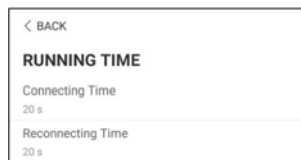

figure 7-13 Running Time

PID Parameters

Tap **Settings**→**Operation Parameters**→**PID Parameters** to enter the corresponding screen, on which you can set "PID Parameters".

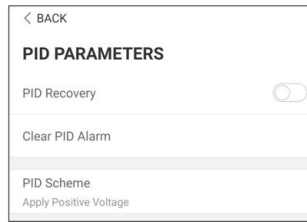

figure 7-14 PID Setting

table 7-8 PID Parameter Description

Parameter	Description
PID Recovery	Set enabling/disabling of the PID night recovery function. PID night recovery function operates between 22:00 pm and 5:00 am by default.
Clear PID alarm	If ISO impedance abnormality or PID function exception is detected during running of the PID function, the inverter reports a PID false alarm and reminds the user to take corresponding measures. After processing, clear the alarm via this parameter.
PID Scheme	Apply negative or positive voltage.

AFCI Parameters

Tap **Settings**→**Operation Parameters**→**AFCI Parameters** to enter the corresponding screen, on which you can set "AFCI Parameters".

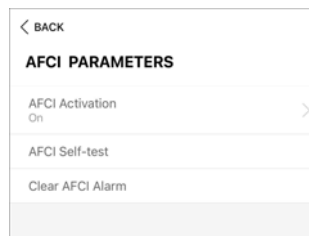

figure 7-15 AFCI Setting

Regular Parameters

Tap **Settings**→**Operation Parameters**→**Regular Parameters** to enter the corresponding screen, on which you can set "Regular Parameters".



figure 7-16 Regular Parameters Setting

7.8.3 Power Regulation Parameters

Active Power Regulation

Tap **Settings**→**Power Regulation Parameters**→**Active Power Regulation** to enter the screen, as shown in the following figure.

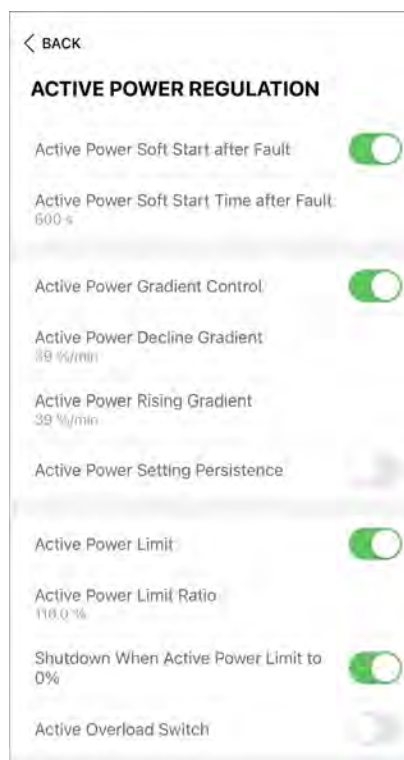

figure 7-17 Active Power Regulation

table 7-9 Active Power Regulation

Parameter	Definition/Setting Description	Range
Active power soft start after fault	The switch for enabling/disabling the soft start function after a fault occurs.	Enable/Disable
Active power soft start time after fault	Time that the soft start takes to raise the power from 0 to 100% rated power.	1s~1200s

Parameter	Definition/Setting Description	Range
Active power gradient control	Switch for enabling/disabling the active power rate settable function.	Enable/Disable
Active power decline gradient	The decline rate of inverter active power per minute.	1%/min~6000%/min
Active power rising gradient	The rise rate of inverter active power per minute.	1%/min~6000%/min
Active power setting persistence	Switch for enabling/disabling the function of saving output limited power.	Enable/Disable
Active power limit	The switch for limiting output power.	Enable/Disable
Active power limit ratio	The ratio of limiting output power to rated power in percentage.	0%~110%
Shutdown when active power limit to 0%	Switch used to determine whether the inverter is in stop state when the limited power reaches 0.	Enable/Disable
Active Overload Switch	Switch used to ensure that the inverter operates at the maximum active power when PV power limit ratio is set over 100%.	Enable/Disable
Ripple Control	Switch for Ripple Control	On/Off

Reactive Power Regulation

Tap **Settings**→**Power Regulation Parameters**→**Reactive Power Regulation** to enter the screen, as shown in the following figure.

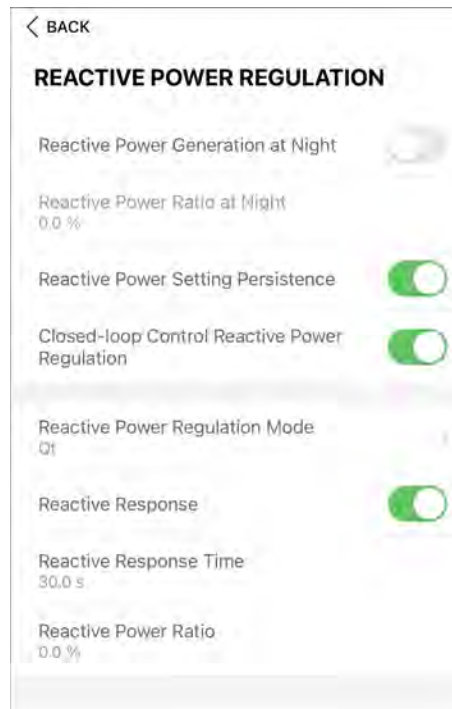

figure 7-18 Reactive Power Regulation

table 7-10 Reactive Power Regulation

Parameter	Definition/Setting Description	Range
Reactive power generation at night	Switch for enabling/disabling reactive power generation at night function.	Enable/Disable
Reactive power ratio at night	Reactive power ratio set for the reactive power generation at night function.	-100%~0%/0%~100%
Reactive power setting persistence	Switch for enabling/disabling the power-off function during reactive power.	Enable/Disable
Reactive power regulation mode	—	Off/PF/Qt/Q(P)/Q(U)

The inverter provides the reactive power regulation function. Enable this function under "Reactive Power Regulation Mode" and select the appropriate mode.

table 7-11 Descriptions of reactive power regulation mode:

Mode	Descriptions
Off	The PF is fixed at +1.000.
PF	The reactive power can be regulated by the parameter PF (Power Factor).
Qt	The reactive power can be regulated by the parameter Q-Var limits (in %).
Q(P)	The PF changes with the output power of the inverter.
Q(U)	The reactive power changes with the grid voltage.

“Off” Mode

The reactive power regulation function is disabled. The PF is limited to +1.000.

“PF” Mode

The power factor is fixed and reactive power setpoint is calculated according to the current power. The PF ranges from 0.8 leading to 0.8 lagging.

Leading: the inverter is sourcing reactive power to the grid.

Lagging: the inverter is injecting reactive power into the grid.

“Qt” Mode

In the Qt mode, system rated reactive power is fixed, and the system injects reactive power according to the delivered reactive power ratio. The **Reactive Power Ratio** is set through the App.

The setting range of the reactive power ratio is 0~100% or 0~-100%, corresponding to the ranges of inductive and capacitive reactive power regulation respectively.

“Q(P)” Mode

The PF of the inverter output varies in response to the output power of the inverter.

table 7-12 “Q(P)” Mode Parameter Descriptions:

Parameter	Explanation	Range
Q(P) Curve	Select corresponding curve according to local regulations	A, B, C*
QP_P1	Output power at P1 on the Q(P) mode curve (in percentage)	0% ~ 100%
QP_P2	Output power at P2 on the Q(P) mode curve (in percentage)	20% ~ 100%
QP_P3	Output power at P3 on the Q(P) mode curve (in percentage)	20% ~ 100%
QP_K1	Power factor at P1 on the Q(P) mode curve	
QP_K2	Power factor at P2 on the Q(P) mode curve	Curve A/C: 0.8 ~ 1 Curve B: - 0.6 ~ 0.6
QP_K3	Power factor at P3 on the Q(P) mode curve	

Parameter	Explanation	Range
QP_EnterVoltage	Voltage percentage for Q(P) function activation	100% ~ 110%
QP_ExitVoltage	Voltage percentage for Q(P) function deactivation	90% ~ 100%
QP_ExitPower	Power percentage for Q(P) function deactivation	1% ~ 100%
QP_EnableMode	Unconditional activation/deactivation of Q (P) function	Yes / No
QU_Limited PF Value	PF value for Q(U) function activation	0~1

* Curve C is reserved and consistent with Curve A currently.

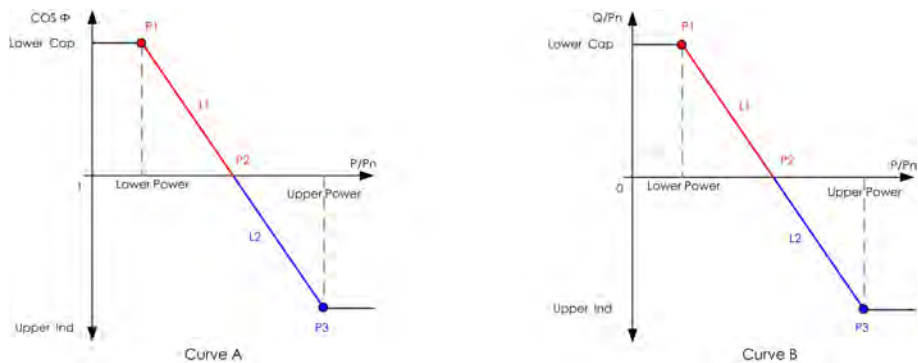

figure 7-19 Q(P) Curve

table 7-13 "Q(U)" Mode Parameter Descriptions:

Parameter	Explanation	Range
Q(U) curve	Select corresponding curve according to local regulations	A, B, C*
Hysteresis Ratio	Voltage hysteresis ratio on the Q(U) mode curve	0 ~ 5%
QU_V1	Grid voltage limit at P1 on the Q(U) mode curve	80% ~ 100%
QU_Q1	Value of Q/Sn at P1 on the Q(U) mode curve	-60% ~ 0
QU_V2	Grid voltage limit at P2 on the Q(U) mode curve	80% ~ 100%
QU_Q2	Value of Q/Sn at P2 on the Q(U) mode curve	-60% ~ 60%
QU_V3	Grid voltage limit at P3 on the Q(U) mode curve	100% ~ 120%
QU_Q3	Value of Q/Sn at P3 on the Q(U) mode curve	-60% ~ 60%

Parameter	Explanation	Range
QU_V4	Grid voltage limit at P4 on the Q(U) mode curve	100% ~ 120%
QU_Q4	Value of Q/Sn at P4 on the Q(U) mode curve	0 ~ 60%
QU_EnterPower	Active power for Q(U) function activation	20% ~ 100%
QU_ExitPower	Active power for Q(U) function deactivation	1% ~ 20%
QU_EnableMode	Unconditional activation/deactivation of Q (U) function	Yes / No / Yes, Limited by PF

* Curve C is reserved and consistent with Curve A currently.

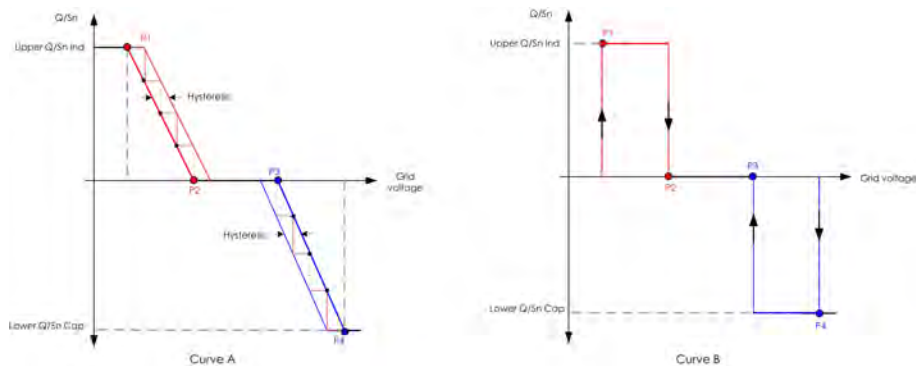

figure 7-20 Q(U) Curve

7.8.4 Communication Parameters

Tap **Settings**→**Communication Parameters**→**Serial Port Parameters** to enter the corresponding interface, as shown in the following figure.

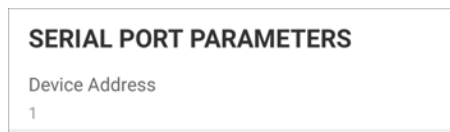

figure 7-21 Serial Port Parameters

table 7-14 Serial Port Parameters

Parameter	Range
Device Address	1–246

7.8.5 Firmware Update

To avoid download failure due to poor on-site network signal, it is recommended to download the firmware package to the mobile device in advance.

- step 1 Enable the "Mobile data" of the mobile device.
- step 2 Open the App, enter the account and password on the login screen. Tap **Login** to enter the home screen.

- step 3 Tap **More**→**Firmware Download** to enter corresponding screen on which you can view the device list.
- step 4 Select the device model before downloading the firmware. Tap the device name in the device list to enter the firmware upgrade package detail interface, and tap  behind the firmware upgrade package to download it.



- step 5 Return to the **Firmware Download** screen, tap  in the upper right corner of the screen to view the downloaded firmware upgrade package.
- step 6 Login the App via local access mode. Refer to "[7.3 Login](#)".
- step 7 Tap **More** on the App home screen and then tap **Firmware Update**.
- step 8 Tap the upgrade package file, a prompt box will pop up asking you to upgrade the firmware with the file, tap **CONFIRM** to perform the firmware upgrade.



- step 9 Wait for the file to be uploaded. When the upgrade is finished, the interface will inform you of the upgrade completion. Tap **Complete** to end the upgrade.



-- End

7.8.6 Password Changing

Tap **Modify Password** to enter the modify password screen, as shown in the following figure.

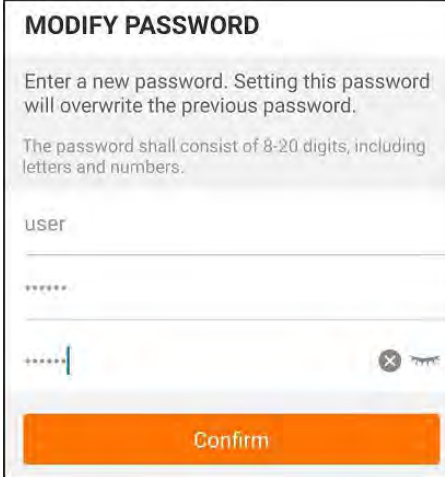

MODIFY PASSWORD

Enter a new password. Setting this password will overwrite the previous password.

The password shall consist of 8-20 digits, including letters and numbers.

user

Confirm

figure 7-22 Change Password

The password shall consist of 8–20 digits, including letters and numbers.

8 System Decommissioning

8.1 Disconnecting the Inverter

CAUTION

Danger of burns!

Even if the inverter is shut down, it may still be hot and cause burns. Wear protective gloves before operating the inverter after it cools down.

For maintenance or other service work, the inverter must be switched off.

Proceed as follows to disconnect the inverter from the AC and DC power sources. Lethal voltages or damage to the inverter will follow if otherwise.

- step 1 Disconnect the external AC circuit breaker and secure it against reconnection.
- step 2 Rotate the DC switch to the "OFF" position for disconnecting all of the PV string inputs.
- step 3 Wait about 15 minutes until the capacitors inside the inverter completely discharge.
- step 4 Ensure that the DC cable is current-free via a current clamp.

-- End

8.2 Dismantling the Inverter

CAUTION

Risk of burn injuries and electric shock!

After the inverter is powered off for 15 minutes, measure the voltage and current with professional instrument. Only when there is no voltage nor current can operators who wear protective equipment operate and maintain the inverter.



Before dismantling the inverter, disconnect both AC and DC connections.

If there are more than two layers of inverter DC terminals, dismantle the outer DC connectors before dismantling the inner ones.

- step 1 Refer to "[5 Electrical Connection](#)", for the inverter disconnection of all cables in reverse steps. In particular, when removing the DC connector, use an MC4-Evo2 wrench to loosen the locking parts and install waterproof plugs.

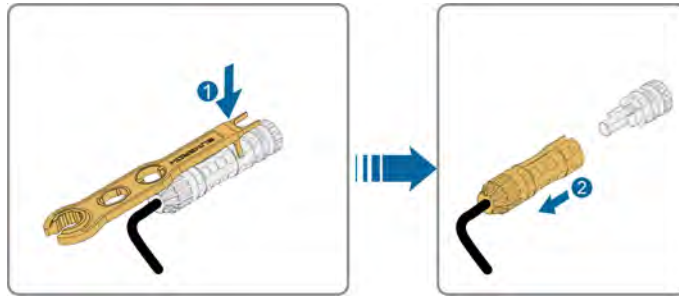

step 2 Refer to "[4 Mechanical Mounting](#)", to dismantle the inverter in reverse steps.

step 3 If necessary, remove the wall-mounting bracket from the wall.

step 4 If the inverter will be used again in the future, please refer to "[3.2 Inverter Storage](#)" for a proper conservation.

-- End

8.3 Disposal of the Inverter

Users take the responsibility for the disposal of the inverter.

⚠ WARNING

Please scrap the inverter in accordance with relevant local regulations and standards to avoid property losses or casualties.

NOTICE

Some parts of the inverter may cause environmental pollution. Please dispose of them in accordance with the disposal regulations for electronic waste applicable at the installation site.

9 Troubleshooting and Maintenance

9.1 Troubleshooting

Once the inverter fails, the fault information can be displayed on the App interface. If the inverter is equipped with an LCD screen, the fault information can be viewed on it.

The fault codes and troubleshooting methods of all PV inverters are detailed in the table below. The device you purchase may only contain some of the fault information, and when the inverter fails, you can check the corresponding information through the fault codes from the mobile app.

Fault code	Fault name	Corrective measures
2, 3, 14, 15	Grid Overvoltage	<p>Generally, the inverter will be reconnected to the grid after the grid returns to normal. If the fault occurs repeatedly:</p> <ol style="list-style-type: none">1. Measure the actual grid voltage, and contact the local electric power company for solutions if the grid voltage is higher than the set value.2. Check whether the protection parameters are appropriately set via the App or the LCD. Modify the overvoltage protection values with the consent of the local electric power operator.3. Contact Sungrow Customer Service if the preceding causes are ruled out and the fault persists.
4, 5	Grid Undervoltage	<p>Generally, the inverter will be reconnected to the grid after the grid returns to normal. If the fault occurs repeatedly:</p> <ol style="list-style-type: none">1. Measure the actual grid voltage, and contact the local electric power company for solutions if the grid voltage is lower than the set value.2. Check whether the protection parameters are appropriately set via the App or the LCD.3. Check whether the AC cable is firmly in place.4. Contact Sungrow Customer Service if the preceding causes are ruled out and the fault persists.

Fault code	Fault name	Corrective measures
8	Grid Overfrequency	Generally, the inverter will be reconnected to the grid after the grid returns to normal. If the fault occurs repeatedly:
9	Grid Underfrequency	<ol style="list-style-type: none"> 1. Measure the actual grid frequency, and contact the local electric power company for solutions if the grid frequency is beyond the set range. 2. Check whether the protection parameters are appropriately set via the App or the LCD. 3. Contact Sungrow Customer Service if the preceding causes are ruled out and the fault persists.
10	Grid Power Outage	<p>Generally, the inverter will be reconnected to the grid after the grid returns to normal. If the fault occurs repeatedly:</p> <ol style="list-style-type: none"> 1. Check whether the grid supplies power reliably. 2. Check whether the AC cable is firmly in place. 3. Check whether the AC cable is connected to the correct terminal (whether the live wire and the N wire are correctly in place). 4. Check whether the AC circuit breaker is connected. 5. Contact Sungrow Customer Service if the preceding causes are ruled out and the fault persists.
12	Excess Leakage Current	<ol style="list-style-type: none"> 1. The fault can be caused by poor sunlight or damp environment, and generally the inverter will be reconnected to the grid after the environment is improved. 2. If the environment is normal, check whether the AC and DC cables are well insulated. 3. Contact Sungrow Customer Service if the preceding causes are ruled out and the fault persists.
13	Grid Abnormal	<p>Generally, the inverter will be reconnected to the grid after the grid returns to normal. If the fault occurs repeatedly:</p> <ol style="list-style-type: none"> 1. Measure the actual grid, and contact the local electric power company for solutions if the grid parameter exceeds the set range. 2. Contact Sungrow Customer Service if the preceding causes are ruled out and the fault persists.

Fault code	Fault name	Corrective measures
17	Grid Voltage Imbalance	<p>Generally, the inverter will be reconnected to the grid after the grid returns to normal. If the fault occurs repeatedly:</p> <ol style="list-style-type: none"> 1. Measure the actual grid voltage. If grid phase voltages differ greatly, contact the electric power company for solutions. 2. If the voltage difference between phases is within the permissible range of the local power company, modify the grid voltage imbalance parameter through the App or the LCD. 3. Contact Sungrow Customer Service if the preceding causes are ruled out and the fault persists.
28, 29, 208, 212, 448-479	PV Reserve Connection Fault	<ol style="list-style-type: none"> 1. Check whether the corresponding string is of reverse polarity. If so, disconnect the DC switch and adjust the polarity when the string current drops below 0.5 A. 2. Contact Sungrow Customer Service if the preceding causes are ruled out and the fault persists. <p>*The code 28 to code 29 are corresponding to PV1 to PV2 respectively.</p> <p>*The code 448 to code 479 are corresponding to string 1 to string 32 respectively.</p>
532-547, 564-579	PV Reverse Connection Alarm	<ol style="list-style-type: none"> 1. Check whether the corresponding string is of reverse polarity. If so, disconnect the DC switch and adjust the polarity when the string current drops below 0.5 A. 2. Contact Sungrow Customer Service if the preceding causes are ruled out and the alarm persists. <p>*The code 532 to code 547 are corresponding to string 1 to string 16 respectively.</p> <p>*The code 564 to code 579 are corresponding to string 17 to string 32 respectively.</p>

Fault code	Fault name	Corrective measures
548-563, 580-595	PV Abnormal Alarm	<p>Check whether the voltage and current of the inverter is abnormal to determine the cause of the alarm.</p> <ol style="list-style-type: none"> 1. Check whether the corresponding module is sheltered. If so, remove the shelter and ensure module cleanness. 2. Check whether the battery board wiring is loose, if so, make it reliably connected. 3. Check if the DC fuse is damaged. If so, replace the fuse. 4. Contact Sungrow Customer Service if the preceding causes are ruled out and the alarm persists. <p>*The code 548 to code 563 are corresponding to string 1 to string 16 respectively.</p> <p>*The code 580 to code 595 are corresponding to string 17 to string 32 respectively.</p>
37	Excessively High Ambient Temperature	<p>Generally, the inverter will resume operation when the internal or module temperature returns to normal. If the fault persists:</p> <ol style="list-style-type: none"> 1. Check whether the ambient temperature of the inverter is too high; 2. Check whether the inverter is in a well-ventilated place; 3. Check whether the inverter is exposed to direct sunlight. Shield it if so; 4. Check whether the fan is running properly. Replace the fan if not; 5. Contact Sungrow Power Customer Service if the fault is due to other causes and the fault persists.
43	Excessively Low Ambient Temperature	<p>Stop and disconnect the inverter. Restart the inverter when the ambient temperature rises within the operation temperature range.</p>

Fault code	Fault name	Corrective measures
39	Low System Insulation Resistance	<p>Wait for the inverter to return to normal. If the fault occurs repeatedly:</p> <ol style="list-style-type: none"> 1. Check whether the ISO resistance protection value is excessively high via the app or the LCD, and ensure that it complies with the local regulations. 2. Check the resistance to ground of the string and DC cable. Take corrective measures in case of short circuit or damaged insulation layer. 3. If the cable is normal and the fault occurs on rainy days, check it again when the weather turns fine. 4. If there are batteries, check whether battery cables are damaged and whether terminals are loose or in poor contact. If so, replace the damaged cable and secure terminals to ensure a reliable connection. 5. Contact Sungrow Customer Service if the preceding causes are ruled out and the fault persists.
106	Grounding Cable Fault	<ol style="list-style-type: none"> 1. Check whether the AC cable is correctly connected. 2. Check whether the insulation between the ground cable and the live wire is normal. 3. Contact Sungrow Customer Service if the preceding causes are ruled out and the fault persists.
88	Electric Arc Fault	<ol style="list-style-type: none"> 1. Disconnect the DC power supply, and check whether any DC cable is damaged, the connection terminal or fuse is loose or there is a weak contact. If so, replace the damaged cable, fasten the terminal or fuse, and replace the burnt component. 2. After performing step 1, reconnect the DC power supply, and clear the electric arc fault via the App or the LCD, after that the inverter will return to normal. 3. Contact Sungrow Customer Service if the fault persists.

Fault code	Fault name	Corrective measures
84	Reverse Connection Alarm of the Meter/CT	<ol style="list-style-type: none"> 1. Check if the meter is wrongly connected. 2. Check if the input and output wiring of the meter is reversed. 3. If the existing system is enabled, please check if the rated power setting of the existing inverter is correct.
514	Meter Communication Abnormal Alarm	<ol style="list-style-type: none"> 1. Check whether the communication cable and the terminals are abnormal. If so, correct them to ensure reliable connection. 2. Reconnect the communication cable of the meter. 3. Contact Sungrow Customer Service if the preceding causes are ruled out and the alarm persists.
323	Grid Confrontation	<ol style="list-style-type: none"> 1. Check whether the output port is connected to actual grid. Disconnect it from the grid if so. 2. Contact Sungrow Customer Service if the preceding causes are ruled out and the fault persists.
75	Inverter Parallel Communication Alarm	<ol style="list-style-type: none"> 1. Check whether the communication cable and the terminals are abnormal. If so, correct them to ensure reliable connection. 2. Reconnect the communication cable of the meter. 3. Contact Sungrow Customer Service if the preceding causes are ruled out and the alarm persists.

Fault code	Fault name	Corrective measures
7, 11, 16, 19– 25, 30–34, 36, 38, 40–42, 44– 50, 52–58, 60– 69, 85, 87, 92, 93, 100–105, 107–114, 116– 124, 200–211, 248–255, 300– 322, 324–328, 401–412, 600– 603, 605, 608, 612, 616, 620, 622–624, 800, 802, 804, 807, 1096–1122	System Fault	<ol style="list-style-type: none"> 1. Wait for the inverter to return to normal. 2. Disconnect the AC and DC switches, and disconnect the battery side switches if there are batteries. Close the AC and DC switches in turn 15 minutes later and restart the system. 3. Contact Sungrow Customer Service if the preceding causes are ruled out and the fault persists.
59, 70–74, 76, 82, 83, 89, 77– 81, 216–218, 220–232, 432– 434, 500–513, 515–518, 635– 638, 900, 901, 910, 911, 996	System Alarm	<ol style="list-style-type: none"> 1. The inverter can continue running. 2. Check whether the related wiring and terminal are abnormal, check whether there are any foreign materials or other environmental abnormalities, and take corresponding corrective measures when necessary. 3. If the fault persists, please contact Sungrow Power Customer Service.
264-283	MPPT Reverse Connection	<ol style="list-style-type: none"> 1. Check whether the corresponding string is of reverse polarity. If so, disconnect the DC switch and adjust the polarity when the string current drops below 0.5 A. 2. Contact Sungrow Customer Service if the preceding causes are ruled out and the fault persists. <p>*The code 264 to code 279 are corresponding to string 1 to string 20 respectively.</p>

Fault code	Fault name	Corrective measures
332-363	Boost Capacitor Overvoltage Alarm	<ol style="list-style-type: none"> <li data-bbox="676 241 1061 264">1. The inverter can continue running. <li data-bbox="676 284 1183 466">2. Check whether the related wiring and terminals are abnormal, check whether there are any foreign materials or other environmental abnormalities, and take corresponding corrective measures when necessary. <p data-bbox="676 486 1141 544">If the fault persists, please contact Sungrow Power Customer Service.</p>
364-395	Boost Capacitor Overvoltage Fault	<ol style="list-style-type: none"> <li data-bbox="676 564 1197 711">1. Disconnect the AC and DC switches, and disconnect the battery side switches if there are batteries. Close the AC and DC switches in turn 15 minutes later and restart the system. <li data-bbox="676 731 1169 789">2. If the fault persists, please contact Sungrow Power Customer Service.
1548-1579	String Current Reflux	<ol style="list-style-type: none"> <li data-bbox="676 809 1197 985">1. Check whether the number of PV modules of the corresponding string is less than other strings. If so, disconnect the DC switch and adjust the PV module configuration when the string current drops below 0.5 A. <li data-bbox="676 1005 1141 1029">2. Check whether the PV module is shaded; <li data-bbox="676 1048 1197 1191">3. Disconnect the DC switch to check whether the open circuit voltage is normal when the string current drops below 0.5 A. If so, check the wiring and configuration of the PV module, <li data-bbox="676 1211 1183 1270">4. Check whether the orientation of the PV module is abnormal.

Fault code	Fault name	Corrective measures
1600 - 1615, 1632 - 1655	PV Grounding Fault	<ol style="list-style-type: none"> 1. When the fault occurs, it is forbidden to directly disconnect the DC switch and unplug PV terminals when the direct current is greater than 0.5 A; 2. Wait until the direct current of the inverter falls below 0.5 A, then disconnect the DC switch and unplug the faulty strings; 3. Do not reinsert the faulty strings before the grounding fault is cleared; 4. If the fault is not caused by the foregoing reasons and still exists, contact Sungrow Customer Service.
1616	System Hardware Fault	<ol style="list-style-type: none"> 1. It is prohibited to disconnect the DC switch when the DC current is greater than 0.5 A when the fault occurs. 2. Disconnect the DC switch only when the inverter DC side current drops below 0.5 A. 3. It is prohibited to power up the inverter again. Please contact Sungrow Customer Service.

9.2 Maintenance

9.2.1 Maintenance Notices

DANGER

Risk of inverter damage or personal injury due to incorrect service!

- **Be sure to use special insulation tools when perform high-voltage operations.**
- **Before any service work, first disconnect the grid-side AC circuit breaker and check the inverter status. If the inverter indicator is off, please wait until night to disconnect the DC switch. If the inverter indicator is on, directly disconnect the DC switch.**
- **After the inverter is powered off for 15 minutes, measure the voltage and current with professional instrument. Only when there is no voltage nor current can operators who wear protective equipment operate and maintain the inverter**
- **Even if the inverter is shut down, it may still be hot and cause burns. Wear protective gloves before operating the inverter after it cools down.**

⚠ CAUTION

To prevent misuse or accidents caused by unrelated personnel: Post prominent warning signs or demarcate safety warning areas around the inverter to prevent accidents caused by misuse.

NOTICE

Restart the inverter only after removing the fault that impairs safety performance. As the inverter contains no component parts that can be maintained, never open the enclosure, or replace any internal components.

To avoid the risk of electric shock, do not perform any other maintenance operations beyond this manual. If necessary, contact SUNGROW for maintenance. Otherwise, the losses caused is not covered by the warranty.

NOTICE

Touching the PCB or other static sensitive components may cause damage to the device.

- **Do not touch the circuit board unnecessarily.**
- **Observe the regulations to protect against electrostatic and wear an anti-static wrist strap.**

9.2.2 Routine Maintenance

Item	Method	Period
System clean	Check the temperature and dust of the inverter. Clean the inverter enclosure if necessary. Check if the air inlet and outlet are normal. Clean the air inlet and outlet, if necessary.	Six months to a year (depend on the dust contents in air.)
Fans	Check whether there is fan warning using App. Check whether there is any abnormal noise when the fan is turning. Clean or replace the fans if necessary (see the following section).	Once a year

Item	Method	Period
Cable entry	Check whether the cable entry is insufficiently sealed or the gap is excessively large, and reseal the entry when necessary.	Once a year
Electrical Connection	Check whether all cable are firmly connected in place. Check whether a cable is damaged, especially the part contacting the metal enclosure.	Six months to a year

9.2.3 Cleaning Air Inlet and Outlet

A significant amount of heat is generated when the inverter is working.

In order to maintain good ventilation, please check to make sure the air inlet and outlet are not blocked.

Clean the air inlet and outlet with soft brush or vacuum cleaner if necessary.

9.2.4 Fan Maintenance

⚠ DANGER

- **Power off the inverter and disconnect it from all power supplies before maintaining fans.**
- **After the inverter is powered off for 15 minutes, measure the voltage and current with professional instrument. Only when there is no voltage nor current can operators who wear protective equipment operate and maintain the inverter.**
- **Fan maintenance must be performed by professionals.**

Fans inside the inverter are used to cool the inverter during operation. If the fans do not operate normally, the inverter may not be cooled down and inverter efficiency may decrease.

Therefore, it is necessary to clean dirty fans and replace the broken fans in a timely manner.

The operation procedure is as follows:

step 1 Stop the inverter (see"8.1 Disconnecting the Inverter")

step 2 Loosen the screw on the sealing plate of the fan module.

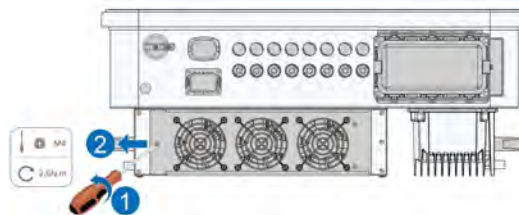

step 3 Press the tab of the latch hook, unplug the cable connection joint outwards, and loosen the screw on the fan holder.

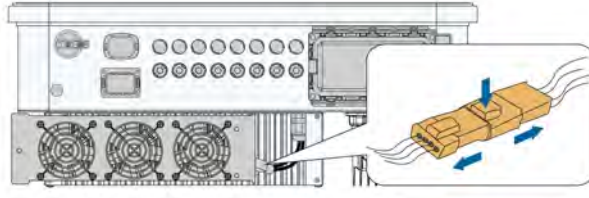

step 4 Pull out the fan module, clean the fans with soft brush or vacuum cleaner, and replace them when necessary.

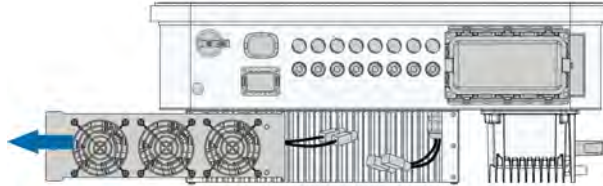

step 5 Reinstall the fan back to the inverter in reverse order and restart the inverter.

-- End

10 Appendix

10.1 Technical Data

Parameters	SG25CX-P2	SG30CX-P2	SG33CX-P2
Input (DC)			
Recommended max. PV input power	35 kWp	42 kWp	46.2 kWp
Max. PV input voltage	1100 V		
Min. PV input voltage / Startup input voltage	160 V / 200 V		
Rated PV input voltage	600 V		
MPP voltage range	160 V ~ 1000 V		
No. of independent MPP inputs	3		
No. of PV strings per MPPT	2		
Max. PV input current	90 A (30 A * 3)		
Max. DC short-circuit current	120 A (40 A * 3)		
Max. current for DC connector	20A		
Output (AC)			
Rated AC output power	25 kVA	30 kVA	33 kVA
Max. AC output power	27.5 kVA	33 kVA (1)	36.3 kVA
Max. AC output current	41.8 A	50.2 A	55.2 A
Rated AC output current(at 230V)	36.2 A	43.5 A	47.8 A
Rated AC voltage	3 / N / PE, 220 / 380 V, 230 / 400 V		
AC voltage range	312 ~ 480 V		

Parameters	SG25CX-P2	SG30CX-P2	SG33CX-P2
Rated grid frequency	50 Hz / 60 Hz		
Grid frequency range	45 – 55 Hz / 55 – 65 Hz		
Harmonic (THD)	< 3 % (at Rated power)		
Power factor at Rated power / Adjustable power factor	> 0.99 / 0.8 leading – 0.8 lagging		
Feed-in phases / connection phases	3 / 3-N-PE		
Efficiency			
Max. efficiency / European efficiency	98.4% / 98.2%	98.5% / 98.3%	98.5% / 98.3%
Protection			
Grid monitoring	Yes		
DC reverse connection protection	Yes		
AC short-circuit protection	Yes		
Leakage current protection	Yes		
Surge protection	DC Type I+II / AC Type II		
Ground fault monitoring	Yes		
DC switch	Yes		
PV String current monitoring	Yes		
Arc fault circuit interrupter (AFCI)	Yes		
PID recovery function	Yes		
General Data			
Dimensions (W*H*D)	645*575*245 mm		
Mounting Method	Wall-mounting bracket		
Weight	38 kg		

Parameters	SG25CX-P2	SG30CX-P2	SG33CX-P2
Topology	Transformerless		
Degree of protection	IP66		
Corrosion	C5		
Night power consumption	< 5W		
Operating ambient temperature range	-30 to 60 °C		
Allowable relative humidity range (non-condensing)	0 – 100 %		
Cooling method	Smart forced air cooling		
Max. operating altitude	4000 m		
Display	LED, Bluetooth+APP		
Communication	RS485 / Optional: WLAN, Ethernet		
DC connection type	EVO2 (Max. 6 mm ²)		
AC connection type	OT terminal (16~35 mm ²)		
AC Cable specification	Outside diameter 18~38mm		
Grid Support	Q at night function, LVRT, HVRT, active & reactive power control and power ramp rate control		

(1) : 30kVA for Germany, Belgium, Austria, Ukraine and Denmark, 33kVA for others.

Parameters	SG36CX-P2	SG40CX-P2	SG50CX-P2
Input (DC)			
Recommended max. PV input power	50.4 kWp	56 kWp	70 kWp
Max. PV input voltage	1100 V		
Min. PV input voltage / Startup input voltage	160 V / 200 V		
Rated PV input voltage	600 V		
MPP voltage range	160 V - 1000 V		
No. of independent MPP inputs	4		

Parameters	SG36CX-P2	SG40CX-P2	SG50CX-P2
No. of PV strings per MPPT		2	
Max. PV input current		120 A (30 A * 4)	
Max. DC short-circuit current		160 A (40 A * 4)	
Max. current for DC connector		20A	
Output (AC)			
Rated AC output power	36 kVA	40 kVA	50 kVA
Max. AC output power	40 kVA	44 kVA	55 kVA
Max. AC output current	60.2 A	66.9 A	83.6 A
Rated AC output current(at 230V)	52.17 A	58 A	72.5 A
Rated AC voltage	3 / N / PE, 220 / 380 V, 230 / 400 V		
AC voltage range	312~480 V		
Rated grid frequency	50 Hz / 60 Hz		
Grid frequency range	45 – 55 Hz / 55 – 65 Hz		
Harmonic (THD)	< 3 % (at Rated power)		
Power factor at Rated power / Adjustable power factor	> 0.99 / 0.8 leading – 0.8 lagging		
Feed-in phases / connection phases	3 / 3-N-PE		
Efficiency			
Max. efficiency / European efficiency	98.5% / 98.3%		
Protection			
Grid monitoring	Yes		
DC reverse connection protection	Yes		

Parameters	SG36CX-P2	SG40CX-P2	SG50CX-P2
AC short-circuit protection		Yes	
Leakage current protection		Yes	
Surge protection		DC Type I+II / AC Type II	
Ground fault monitoring		Yes	
DC switch		Yes	
PV String current monitoring		Yes	
Arc fault circuit interrupter (AFCI)		Yes	
PID recovery function		Yes	
General Data			
Dimensions (W*H*D)		645*575*245 mm	
Mounting Method		Wall-mounting bracket	
Weight	40 kg	40 kg	41 kg
Topology		Transformerless	
Degree of protection		IP66	
Corrosion		C5	
Night power consumption		< 5W	
Operating ambient temperature range		-30 to 60 °C	
Allowable relative humidity range (non-condensing)		0 – 100 %	
Cooling method		Smart forced air cooling	
Max. operating altitude		4000 m	
Display		LED, Bluetooth+APP	
Communication		RS485 / Optional: WLAN, Ethernet	
DC connection type		EVO2 (Max. 6 mm ²)	

Parameters	SG36CX-P2	SG40CX-P2	SG50CX-P2
AC connection type	OT terminal (16~35 mm ²)	OT terminal (16~35 mm ²)	OT or DT terminal (35~50 mm ²)
AC Cable specification	Outside diameter 18~38mm		
Grid Support	Q at night function, LVRT, HVRT, active & reactive power control and power ramp rate control		
Parameters	SG30CX-P2 (2)	SG50CX-P2 (2)	
Input (DC)			
Recommended max. PV input power	45 kWp	76 kWp	
Max. PV input voltage	1100 V		
Min. PV input voltage / Startup input voltage	160 V / 200 V		
Rated PV input voltage	600 V		
MPP voltage range	160 V - 1000 V		
MPP voltage range for Rated power	500V - 800 V		
No. of independent MPP inputs	3	4	
No. of PV strings per MPPT	2		
Max. PV input current	90 A (30 A / 30 A / 30 A)	120 A (30 A / 30 A / 30 A / 30 A)	
Max. DC short-circuit current	120 A (40 A / 40 A / 40 A)	160 A (40 A / 40 A / 40 A / 40 A)	
Max. current for DC connector	20A		
Output (AC)			
Rated AC output power	29.9 kVA	50 kVA	
Max. AC output apparent power	29.9 kVA	50 kVA	
Rated AC output apparent power	29.9 kVA	50 kVA	
Max. AC output current	48.15 A	80.5 A	
Rated AC voltage	3 / N / PE, 220 / 380 V, 230 / 400 V	3 / N / PE, 220 / 380 V, 230 / 400 V	

Parameters	SG30CX-P2 (2)	SG50CX-P2 (2)
AC voltage range	312 - 480 V	
Rated grid frequency	50 Hz / 60 Hz	
Rated grid frequency+B42:H42	45 – 55 Hz / 55 – 65 Hz	
Harmonic (THD)	< 3 % (at rated power)	
Power factor at rated power / Adjustable power factor	> 0.99 / 0.8 leading – 0.8 lagging	
Feed-in phases / connection phases	3 / 3-N-PE	
Efficiency		
Max. efficiency / European efficiency	98.5% / 98.3%	
Protection		
Grid monitoring	Yes	
DC reverse connection protection	Yes	
AC short-circuit protection	Yes	
Leakage current protection	Yes	
Surge protection	DC Type I+II / AC Type II	
Ground fault monitoring	Yes	
DC switch	Yes	
PV String current monitoring	Yes	
Arc fault circuit interrupter (AFCI)	Yes	
PID recovery function	Yes	
General Data		
Dimensions (W*H*D)	645*575*245 mm	
Mounting Method	Wall-mounting bracket	
Weight	38 kg	41 kg
Topology	Transformerless	
Degree of protection	IP66	

Parameters	SG30CX-P2 (2)	SG50CX-P2 (2)
Corrosion		C5
Night power consumption		< 4W
Operating ambient temperature range	-30 to 60 °C (> 45 °C derating)	
Allowable relative humidity range (non-condensing)	0 – 100 %	
Cooling method	Smart forced air cooling	
Max. operating altitude	4000 m	
Display	LED, Bluetooth+APP	
Communication	RS485 / Optional: WLAN, Ethernet	
DC connection type	Evo2 (Max. 6 mm ²)	
AC connection type	OT terminal (16~35 mm ²)	OT or DT terminal (35~50 mm ²)
AC Cable specification	Outside diameter 18~38mm	
Grid Support	Q at night function, LVRT, HVRT, active & reactive power control and power ramp rate control	

(2) :For Australia.

10.2 Wiring Distance of DI Dry Contact

The maximum wiring distance of DC dry contact must meet the requirements in the Table below. The wiring distance L is the total length of all DI signal cables.

$$L = 2 \sum_{k=1}^n L_k$$

L_k refers to the cable length in one direction between the DI dry contact terminal of the k^{th} inverter and the corresponding terminal of the $(k-1)^{\text{th}}$ inverter.

table 10-1 Correspondence between number of inverters and maximum wiring distance

Number of inverter	Maximum wiring distance(unit:m)	
	16AWG / 1.31mm ²	17AWG / 1.026mm ²
1	13030	10552
2	6515	5276
3	4343	3517

Number of inverter	Maximum wiring distance(unit:m)	
	16AWG / 1.31mm ²	17AWG / 1.026mm ²
4	3258	2638
5	2606	2110
6	2172	1759
7	1861	1507
8	1629	1319
9	1448	1172
10	1303	1055
11	1185	959
12	1086	879
13	1002	812
14	931	754
15	869	703
16	814	660
17	766	621
18	724	586
19	686	555
20	652	528
21	620	502
22	592	480
23	567	459
24	543	440
25	521	422

NOTICE

In case the specification of the cable used is not included in the Table above, when there is only one inverter, ensure that the line impedance of the input node is less than 300Ω; and when there are multiple inverters connected in the daisy chain, ensure that the impedance is less than 300Ω/number of inverter.

10.3 Quality Assurance

When product faults occur during the warranty period, SUNGROW will provide free service or replace the product with a new one.

Evidence

During the warranty period, the customer shall provide the product purchase invoice and date. In addition, the trademark on the product shall be undamaged and legible. Otherwise, SUNGROW has the right to refuse to honor the quality guarantee.

Conditions

- After replacement, unqualified products shall be processed by SUNGROW.
- The customer shall give SUNGROW a reasonable period to repair the faulty device.

Exclusion of Liability

In the following circumstances, SUNGROW has the right to refuse to honor the quality guarantee:

- The free warranty period for the whole machine/components has expired.
- The device is damaged during transport.
- The device is incorrectly installed, refitted, or used.
- The device operates in harsh conditions beyond those described in this manual.
- The fault or damage is caused by installation, repairs, modification, or disassembly performed by a service provider or personnel not from SUNGROW.
- The fault or damage is caused by the use of non-standard or non-SUNGROW components or software.
- The installation and use range are beyond stipulations of relevant international standards.
- The damage is caused by unexpected natural factors.

For faulty products in any of above cases, if the customer requests maintenance, paid maintenance service may be provided based on the judgment of SUNGROW.

10.4 Contact Information

In case of questions about this product, please contact us.

We need the following information to provide you the best assistance:

- Model of the device
- Serial number of the device
- Fault code/name
- Brief description of the problem

For detailed contact information, please visit: <https://en.sungrowpower.com/contactUS>.

SUNGROW

Sungrow Power Supply Co., Ltd.
www.sungrowpower.com