

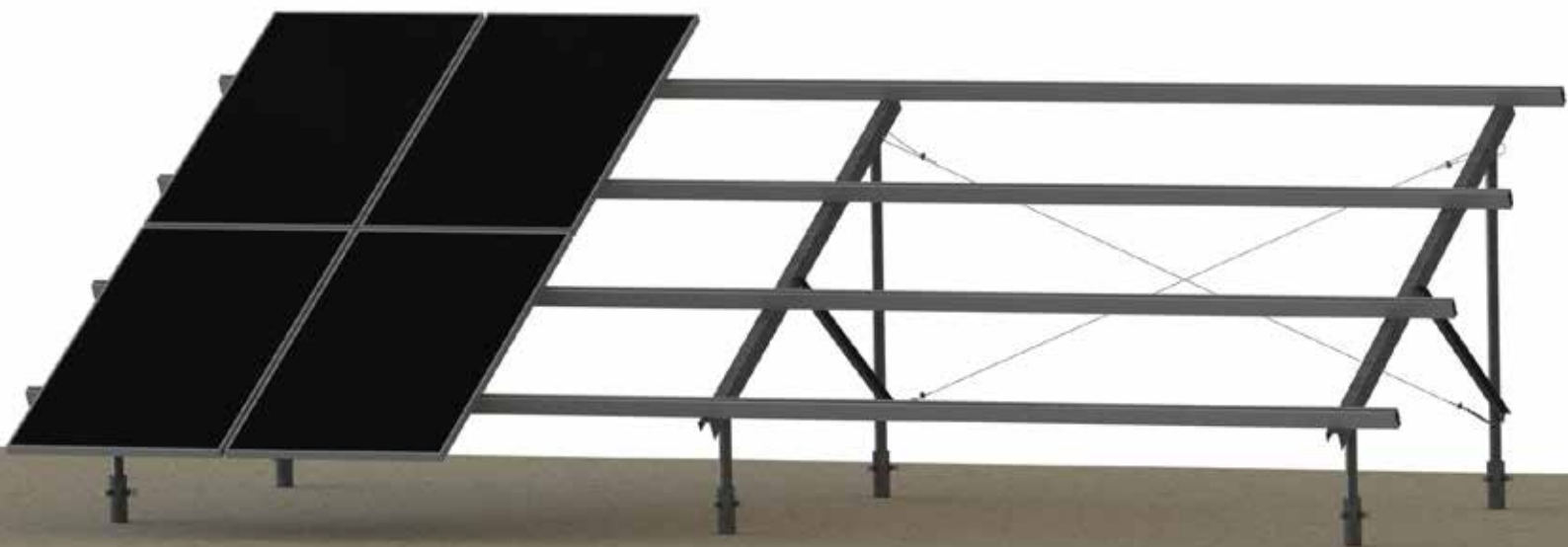

PARK TEGRA **GROUND ANCHOR**



R3 Bourton Industrial Park, Bourton on the Water, Glos, GL54 2HQ, UK

Tel: +44 1451 824 312

Email: info@sunfixings.co.uk

WWW.SUNFIXINGS.CO.UK

V062018

2

Use the layout to mark out the Ground Anchor positions

Tools & Items Required

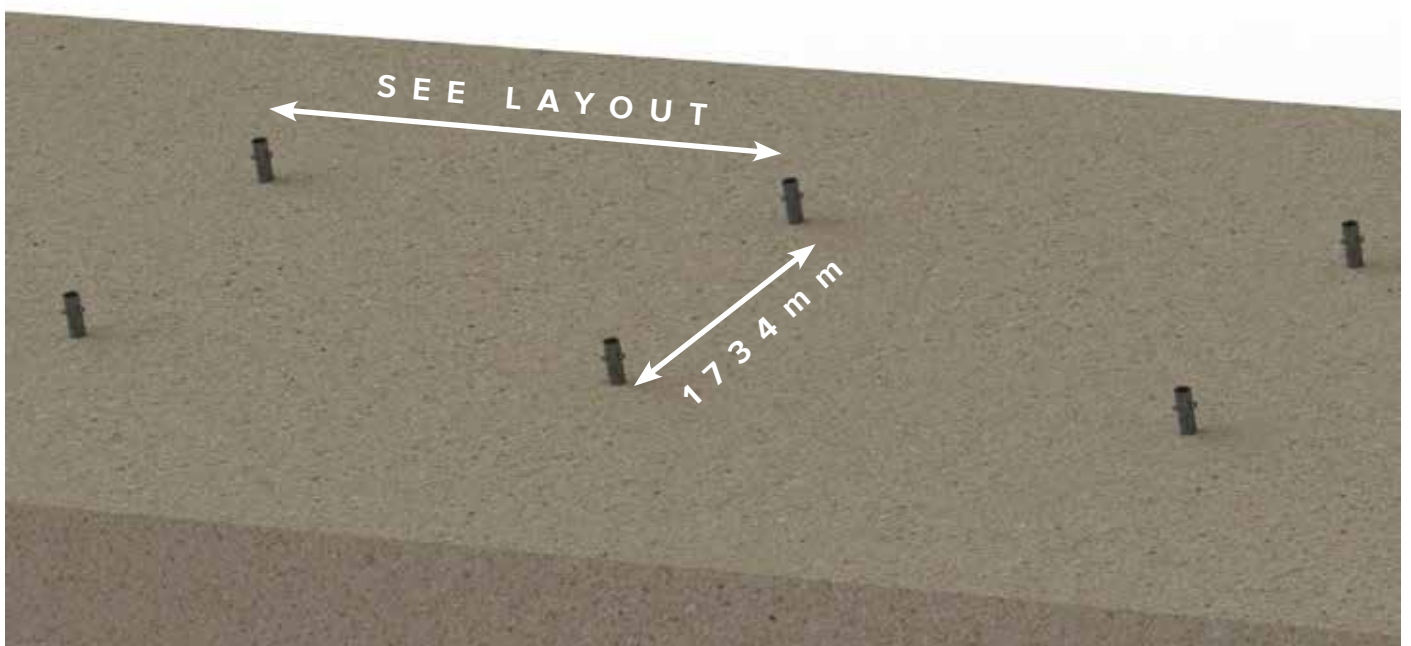
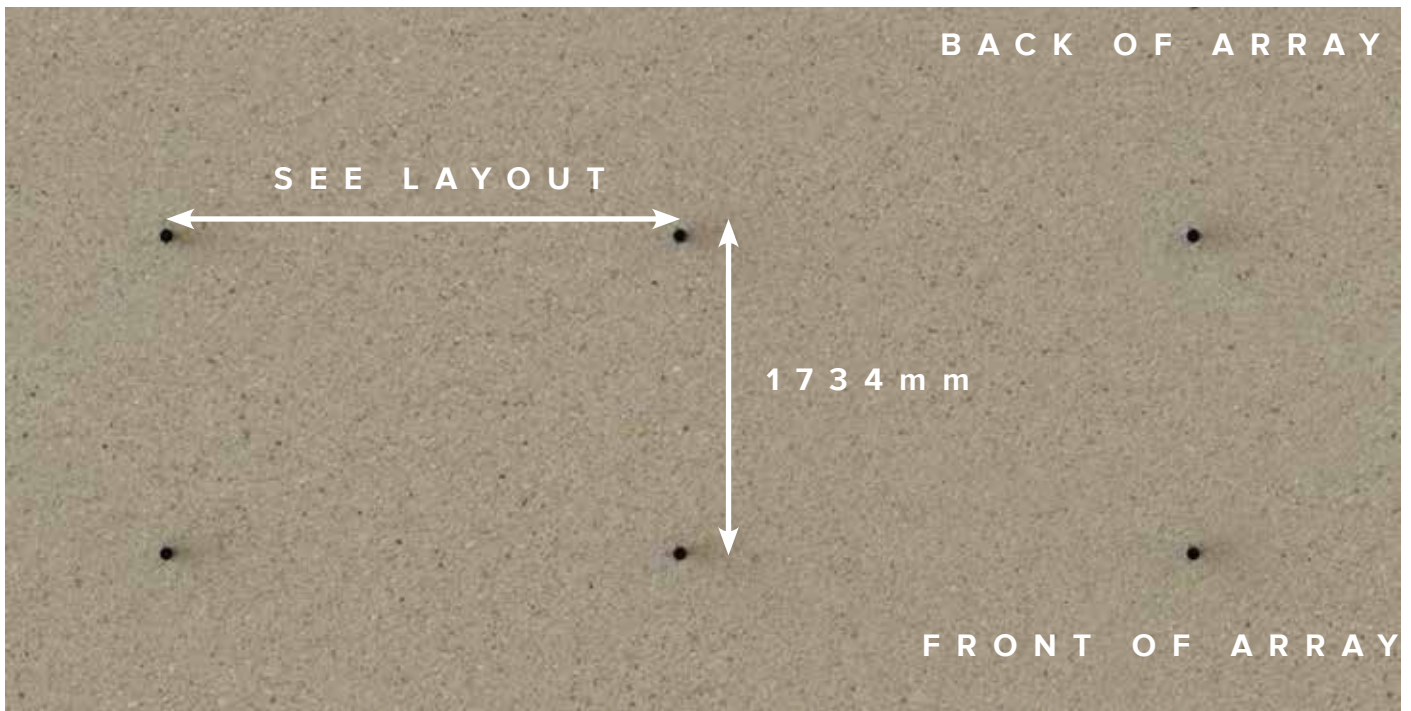
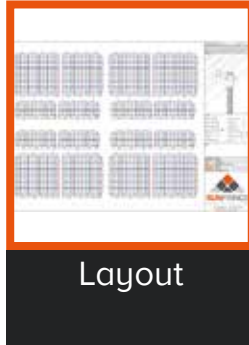

3

Screw in the Ground Anchors

Tools & Items Required



Hydraulic Auger Unit



Auger Adapter



Ground Anchor

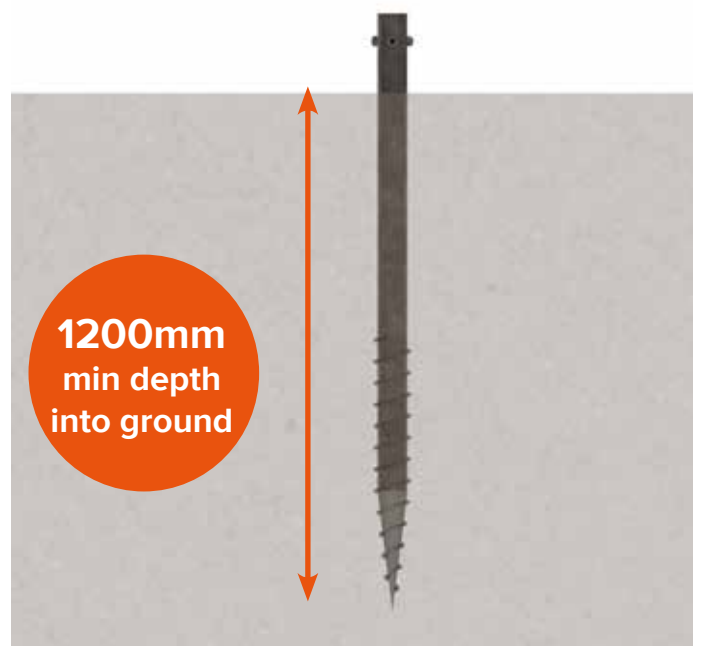
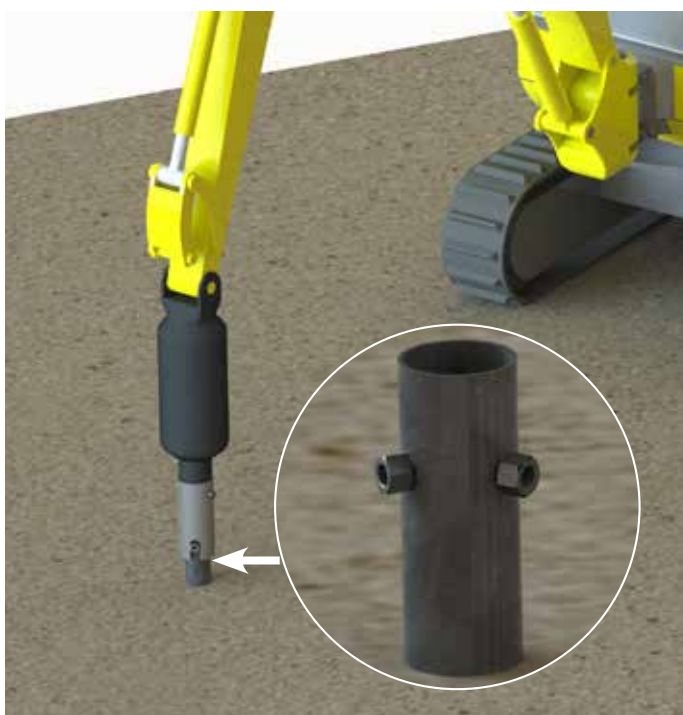

4

The Park Tegra Frame

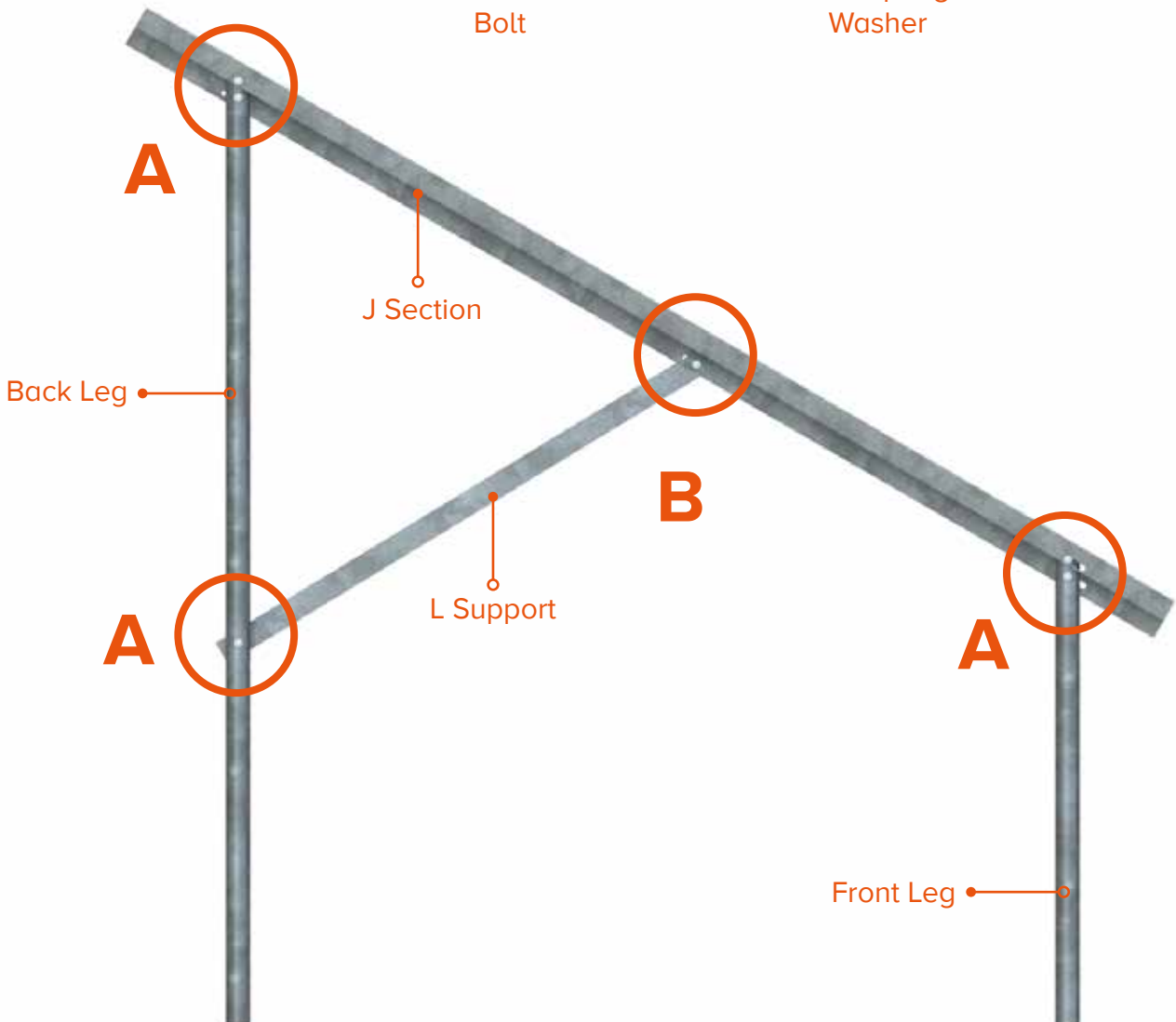
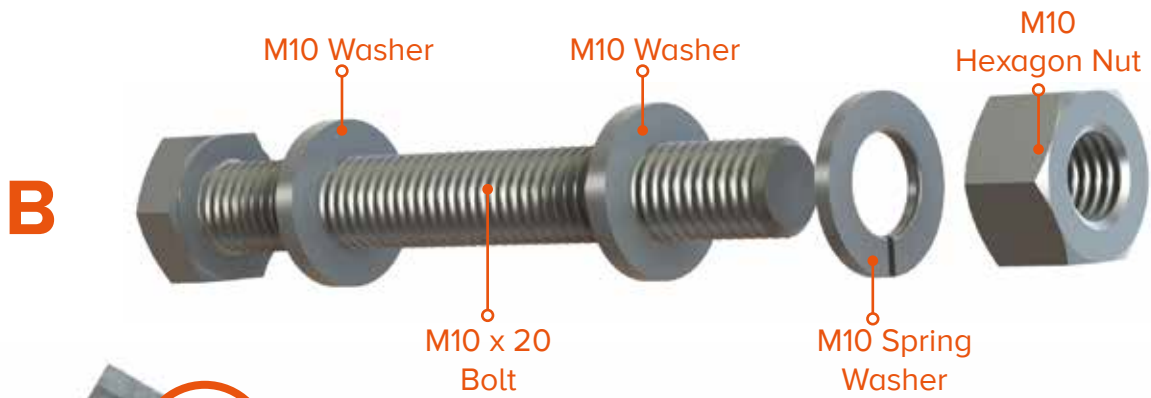
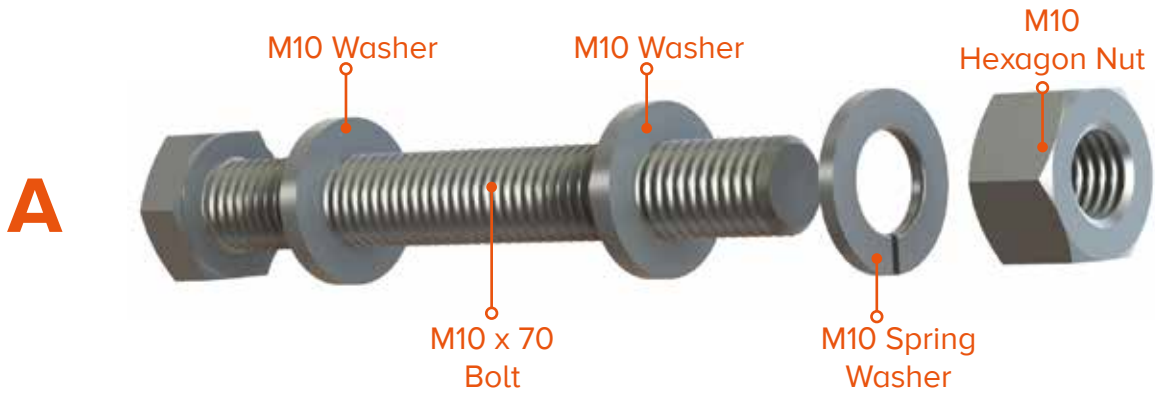

5

Assembling the Park Tegra Frame

Tools & Items Required



17mm Socket
Wrench

35Nm

35Nm

6

Attach the Park Tegra Frame to the Ground Anchors

Tools & Items Required



24mm Socket Wrench

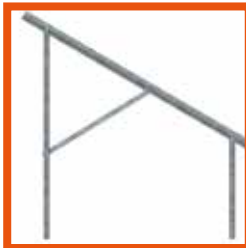

Park Tegra Frame



Ground Anchor

Galvanisation spray is provided for any scratches made into any of the steel items. Follow the instructions on the spray.

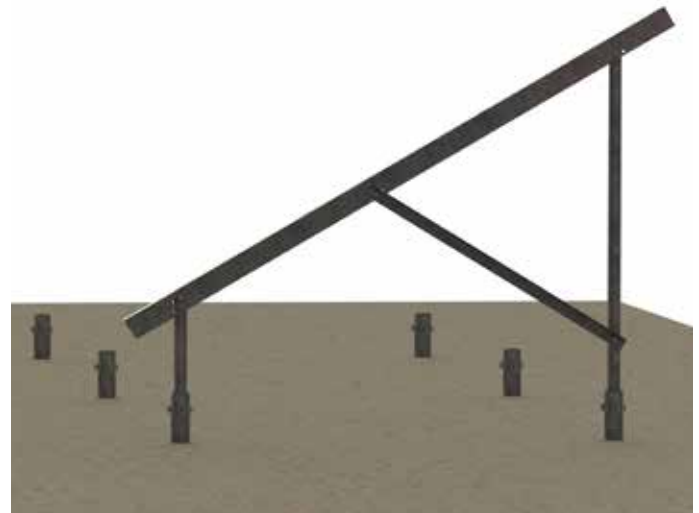
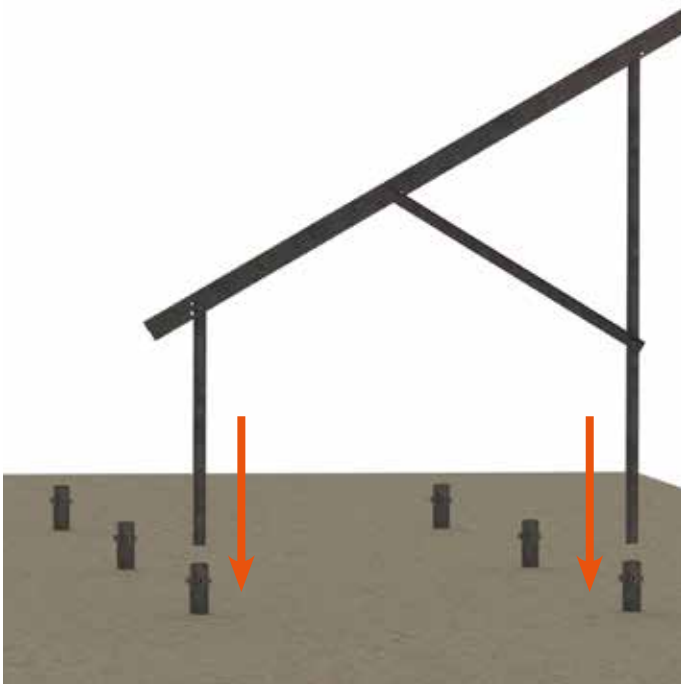

7

Attaching the Mounting Rail

Tools & Items Required



15mm Spanner



Park Tegra Frame



M10 T Bolt



Penny Washer



M10 Serrated Nut



Mounting Rail

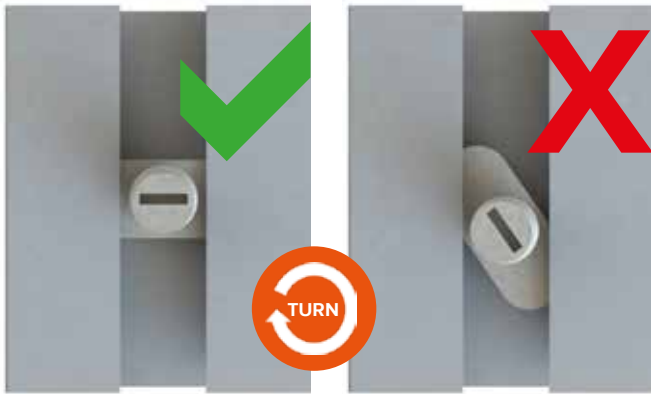
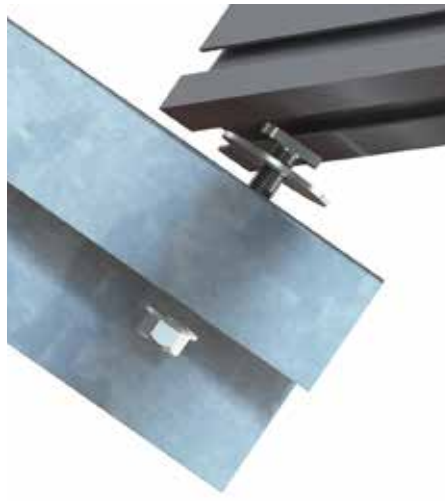

8

Attaching Wind Bracing

Tools & Items Required



Layout



8mm Spanner



Turnbuckle



Clip

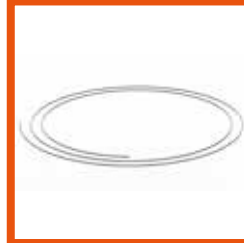

Tension Cable



Park Tegra
Frame

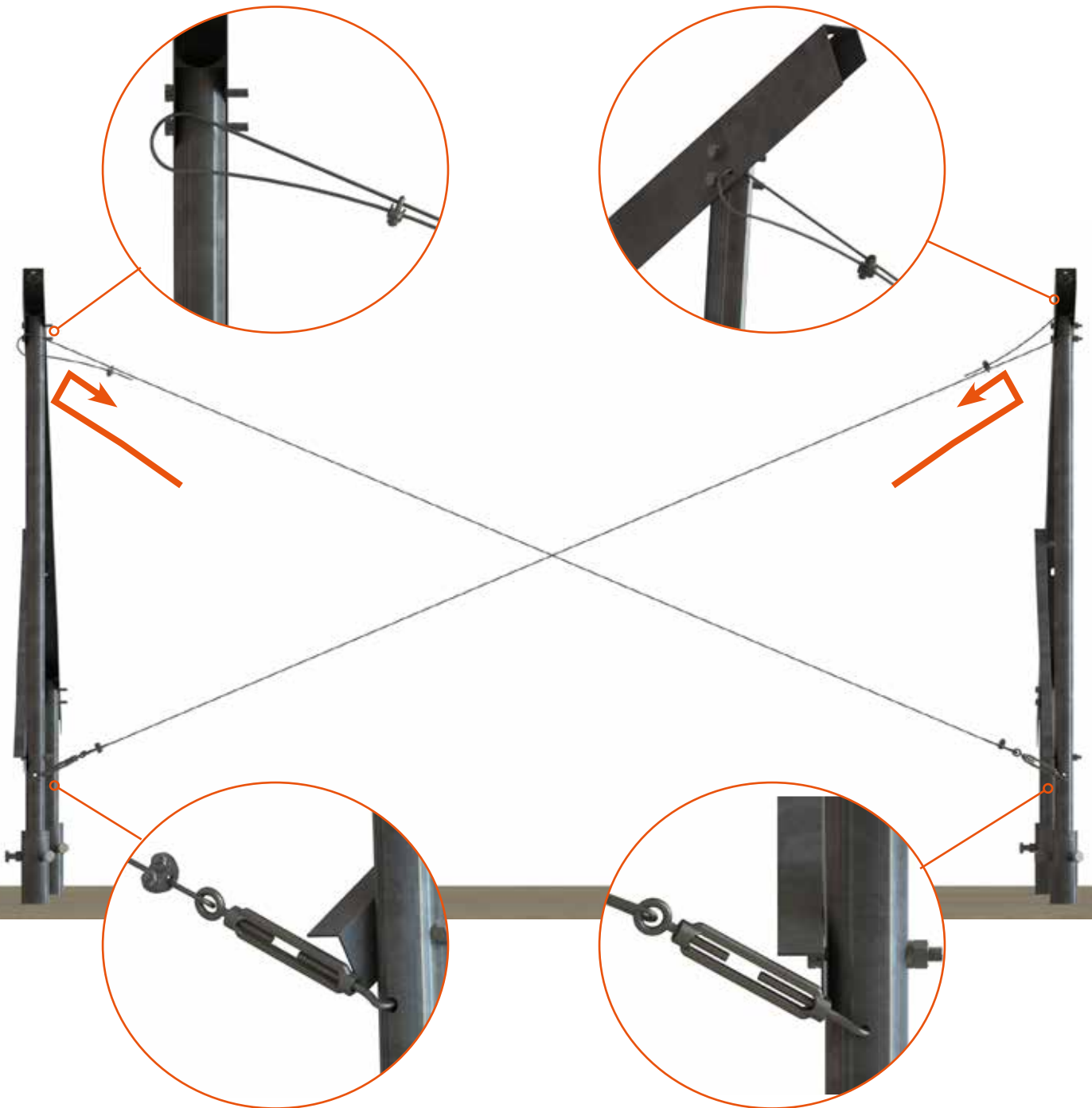

9

Attaching Wind Bracing

Tools & Items Required



Layout



8mm Spanner



Turnbuckle



Clip



Tension Cable



Park Tegra
Frame

