

Operating Manual

Low Voltage Hyper Series

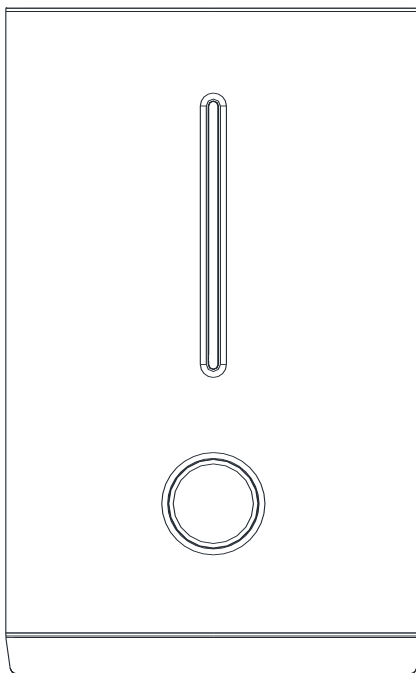

Version: HYPER-LV-1P-EU-1.08

CONTENTS

CONTENTS	1
1. About This Manual.....	2
1.1 Products Covered by This Manual.....	2
1.2 Target Group.....	2
1.3 Symbols Used	2
1.4 Storage of the Manual.....	2
2. Safety.....	3
2.1 Intended Use	3
2.2 Important Safety Instructions	3
3. Scope of Delivery	5
4. Product Description	7
4.1 View of the Inverter	7
4.2 System Diagram.....	9
4.3 Operating Mode Introduction	9
5. Mounting.....	12
5.1 Requirements for Mounting	12
5.2 Mounting the Inverter.....	13
6. Electrical Connection	15
6.1 Wiring Diagram	15
6.2 Overview of the Connection Area.....	16
6.3 PV Connection.....	17
6.4 Grid Connection.....	18
6.5 EPS Connection	20
6.6 Battery Connection.....	21
6.7 Smart Meter Connection	23
6.8 WiFi Stick Connection	25
6.9 DRM Connection	25
7. Operating of the Inverter	26
7.1 LEDs and Graphical Display	26
7.2 Commission	28
7.3 Decommission.....	29
7.4 Settings on the Soltaro APP.....	30
8. Troubleshooting	39
9. Technical Data	41
9.1 Hyper 2000/3000	41
9.2 Hyper 3680/4600/5000.....	43
9.3 Certificates and Grid Regulations	45
Contacts:.....	46

1. About This Manual

1.1 Products Covered by This Manual





Hyper Series Low Voltage Solar Hybrid Inverter:
Hyper 2000, Hyper 3000, Hyper 3680, Hyper 4600, Hyper 5000.

1.2 Target Group

This document is intended for qualified electrician. Any electrical installation and maintenance on this inverter must be performed by qualified electricians in compliance with standards, wiring rules or requirements of local grid authorities or bodies.

1.3 Symbols Used

The following types of safety precautions and general information symbols are used in this manual. These important instructions must be followed during installation, operation and maintenance of the inverter.

	Indicates a hazard with a high level of risk that will result in death or serious injury.
	Indicates a hazard with a medium level of risk that can result in death or serious injury.
	Indicates a hazard with a low level of risk that can result in minor or moderate injury.
	Indicates a situation which, if not avoided, can result in property damage.

1.4 Storage of the Manual

The manual should be stored with other documents belonging to the inverter and must be available to people authorized to work

on the installation.

This manual will be updated if necessary. Please check www.soltaro.com for more information.

2. Safety

2.1 Intended Use

The **Hyper Series** are single phase solar hybrid inverters suitable for both on-grid and off-grid operation. With Lithium batteries, PV panels and a smart meter, the hybrid inverter is the central device to make a solar storage system for increased self-consumption. The **Hyper Series** must only be connected with a Soltaro lithium battery.

To prevent personal injury and property damage and to ensure long-term operation of the product, please read and follow all the instructions and cautions on the inverter and this user manual during installation, operation or maintenance at all times.

2.2 Important Safety Instructions

DANGER

Danger to life from electric shock.

- Before performing any work on the inverter, disconnect all DC and AC power from inverter and wait for at least 5 minutes.
 - Do not touch DC conductors or any non-isolated cable ends.
 - If an error occurs, contact your local distributor or qualified electricians.
 - Make sure the inverter is not touchable from children.
-

WARNING

Risk of burns from hot surfaces.

- The surface of the inverter might exceed 60°C, touching
-

the surface may result in burns.

- Do not touch hot surfaces before it cools down.
 - Only authorized service personnel are allowed to install the inverter or perform servicing and maintenance
 - All powers, both AC and DC, should be disconnected from inverter before attempting any maintenance or cleaning or working on any circuits connected to inverter.
-







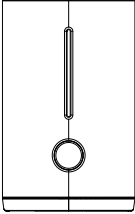
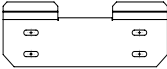

 **CAUTION**

- The Inverter has a transformerless design on PV side. Either positive or negative terminals of PV panels should not be grounded.
 - The frames of PV panels should be grounded for safety reasons.
-

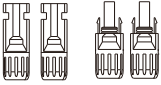
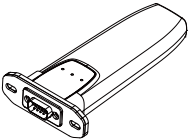
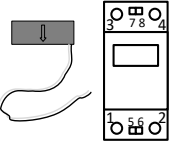
NOTICE

- Do not open inverter cover or change any components without authorization, otherwise the warranty commitment for the inverter will be invalid.
 - Appropriate methods must be adopted to protect inverter from electrostatic discharge, any damage caused by ESD is not warranted by the manufacturer.
-

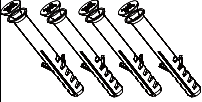
3. Scope of Delivery

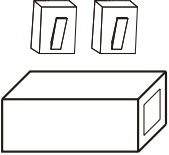
 <p>A</p>	 <p>B</p>	 <p>C</p>	 <p>D</p>
 <p>E</p>	 <p>F</p>	 <p>G</p>	 <p>H</p>
 <p>I</p>	 <p>J</p>	 <p>K</p>	 <p>L</p>
 <p>M</p>			

Item	QTY	Designation
A	1	Inverter
B	1	Wall Mounting Bracket
C	1	EPS Connector (Amphenol or Wieland)
D	1	Grid Connector (Phoenix or Wieland)
E	2 or 4	PV Connectors (Amphenol HC4 or Multi-Contact MC4)
F	1	WiFi Stick
G	1	Smart Meter
H	3	120 Ohm, 240Ohm, 510Ohm Terminal Resistor
I	1	Smart Meter Cable
J	1	Water-proof RJ45 Connector for DRM port
K	4	Screws for Fixing Mounting Bracket
L	1	Manual
M	2	RJ45 Connectors and Communication Cable Extender

4. Product Description

Thank you for choosing a Soltaro, hybrid solar inverter. Features of the Soltaro inverter are ahead of the field and understood prior to install.

4.1 View of the Inverter

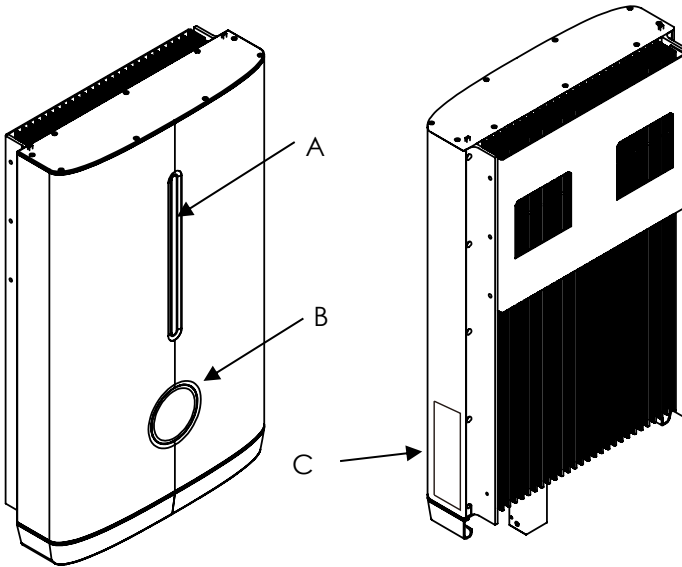











Figure 1. View of the Hyper Series Hybrid Inverter

Position	Designation
A	LEDs The LEDs indicate the operating status of the inverter and SOC of the battery connected.
B	Graphical Display
C	Label

Symbols on the Type Label

Symbol	Explanation
	CE Mark
	Caution, Risk of Danger
	Caution, Risk of Electric Shock
	Caution, Hot Surface.
	Refer to the Operating Manual
	Danger, Risk of Electric Shock due to Stored Energy. Cut off all power and wait at least 5 minutes before any work is carried out on the inverter.
	G83 or G59 Mark for UK.
	RCM Mark for Australia and New Zealand.
	WEEE Mark. This inverter should not be disposed as ordinary waste.

4.2 System Diagram

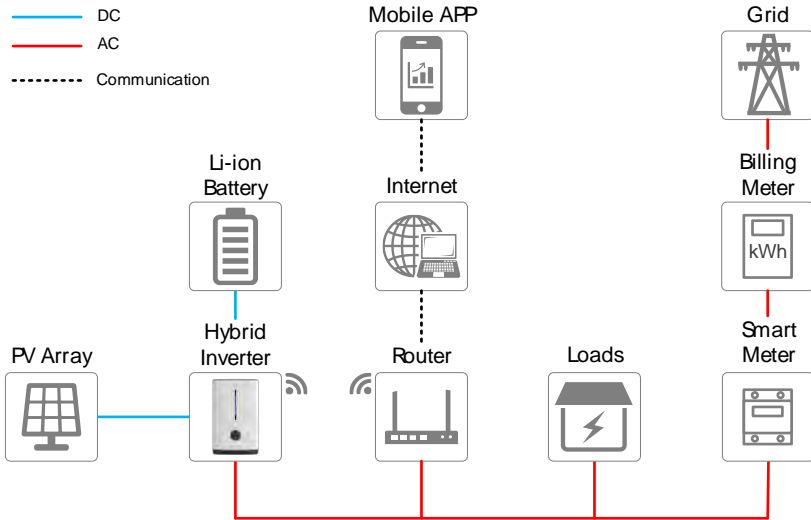

4.3 Operating Mode Introduction

4.3.1 On Grid Self-Use Operating Mode

The on grid self-use operating mode is recommended for the system installed in area with a stable grid. The purpose is to increase self-consumption of the clean PV energy. When Inverter is set to work in this mode:

i. During daytime and there is sufficient PV Power,

- The PV energy is used to supply local loads with first priority and then charge the battery, excessive energy will be fed into grid*1*2.
- When battery is fully charged, PV energy is supplied to the local loads and fed into grid*1*2.

ii. During nighttime or there is not sufficient PV Power,

- Battery is discharged to supply local loads, if extra power is required, it will be imported from grid.
- When the battery SOC is below the setting value or fully discharged, the inverter will stop working and local loads will

be supplied from grid.

- Thanks to the on-grid operation, the switch from battery power, PV power and grid power is automatically and seamless.

iii. When grid fails,

- When grid fails, the inverter will automatically disconnect from grid and outputs power to the EPS port.
- When battery is discharged to the SOC lower threshold, the inverter will stop working and wait for the grid to recovery or there is sufficient power from PV panels to charge the battery.
- If grid fail is not so rare in your area, please do not set the battery SOC lower threshold too low just in case.

iv. You can also:

- Set a schedule for the inverter to charge the battery using cheap off-peak grid power.
- Specify the daily working periods of self-use for inverter.

*1: The inverter can be set not to feed power into the grid. But a small amount of energy will still inevitably be fed into grid due to unpredictable PV energy change and load on/off.

*2: Firmware update may be required to support this function.

NOTICE

For on-grid self-use operating mode, one can set the discharge end SOC@Grid as low as the battery allows (10% or 20% for example). Please refer to your local Soltaro battery technician for minimum discharging end SOC.

4.3.2 Off Grid / Back-up Operating Mode*3

For system installed in area with a weak grid or even without grid, the inverter should be working in off grid / back-up operating mode:

i. When grid or diesel generator is available,

- The battery will be charged firstly from PV and secondly from

grid at the max allowable current.

- The battery will not discharge even when SOC reaches 100%.
- Local loads will be supported by grid and PV energy.

ii. When grid or diesel generator is not available,

- When there is enough energy stored in battery, the EPS port will export power to support local loads firstly from PV. If there's excessive PV energy, it will be used to charge the battery. Otherwise battery will be discharged.
- When the battery SOC is below the lower threshold, the inverter will stop export power to the EPS port. All energy from PV will be used to charge the battery until the SOC reaches the EPS restart value.

iii. When working in this mode:

- The max power*3 from the EPS port is limited by inverter type, battery type and battery SOC.
- A larger battery is always recommended for off grid / back up configuration. You should never discharge the battery too deeply to avoid it "Running Flat".
- When there is overload or short circuit fault, the inverter will stop working and alarm will sound. It will try to restart several times before totally shutting down. Turn off or unplug load to remove the short circuit fault or overload as soon as possible.

*2: Firmware update may be required to support this mode.

*3: Please be noted that refrigerators, air conditioners, water pumps and etc., demand a large start up currents and may trip EPS overload protection. Be sure not to connect too many of this kind of loads to avoid frequent system shutdown and restart.

NOTICE

For off-grid / back-up operating mode, one should set a higher discharge end SOC@Grid (above 50% for example). So that there will be some energy in battery when a grid blackout occurs.

5. Mounting

5.1 Requirements for Mounting

NOTICE

Check to make sure the installation site does not fall into any of the following conditions: If any do, then a risk assessment will be required.



No direct sunlight



No rain exposure



No snow lay up

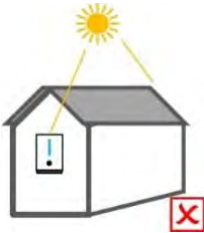

Direct sunlight



Rain exposure



Snow lay up

- Unsafe due to assessment of occupational health safety risks.
- The ambient temperature is outside the range of tolerable ambient temperature (-20°C to +60°C, -4°F to +140°F).
- Higher than the altitude of 2,000m above sea level. Above 2000m the inverter output will be de-rated.
- Close to flammable materials or areas where flammable materials are stored.
- Prone to be damaged by sea water.
- Prone to be flooded or high levels of snow falls.
- Close to corrosive gas or liquid (for example, locations where

chemicals are processed or stored).

- Exposed to direct sunlight or in an enclosure exposed to direct sunlight.
- Little or no air flow
- Mounted on a surface without suitable fire/heat rating.
- Mounted on a wall without suitable load holding capacity.
- High humidity.
- Sites considered unsafe because of local regulations.
- Confined space without adequate airflow.
- Area subject to sand or dust storms.
- Exposed to steam, vapor, or water.
- Near antenna and/or data cables.

5.2 Mounting the Inverter

Procedure:

CAUTION

The converter must be mounted in upright position with a maximal tilt angle of 15 degree.

Minimum clearances around inverter should be applied, as the following figure shown.

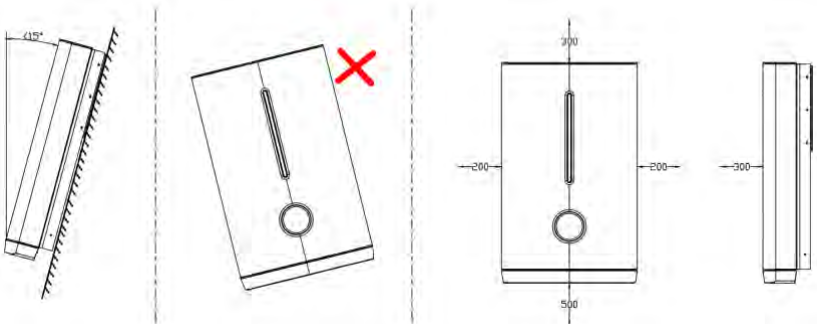

STEP 1:

- Please use the wall mounting bracket as template to drill 4 holes on walls.

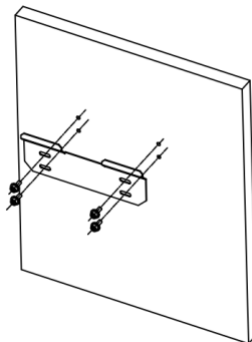

STEP 2:

- Use expansion bolts or correct wall fixings to attach the mounting bracket on the wall tightly.

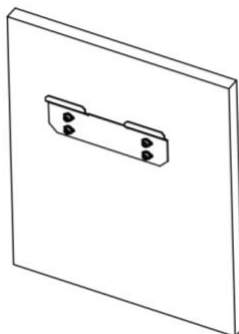

STEP 3:

- Lift and hang the inverter on the bracket.

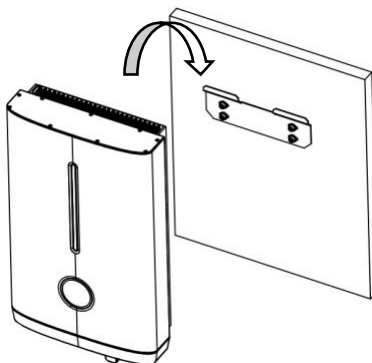

STEP 4:

- Peel off the protective film on the front surface.
-

6. Electrical Connection

6.1 Wiring Diagram

Wiring Diagram for European Countries

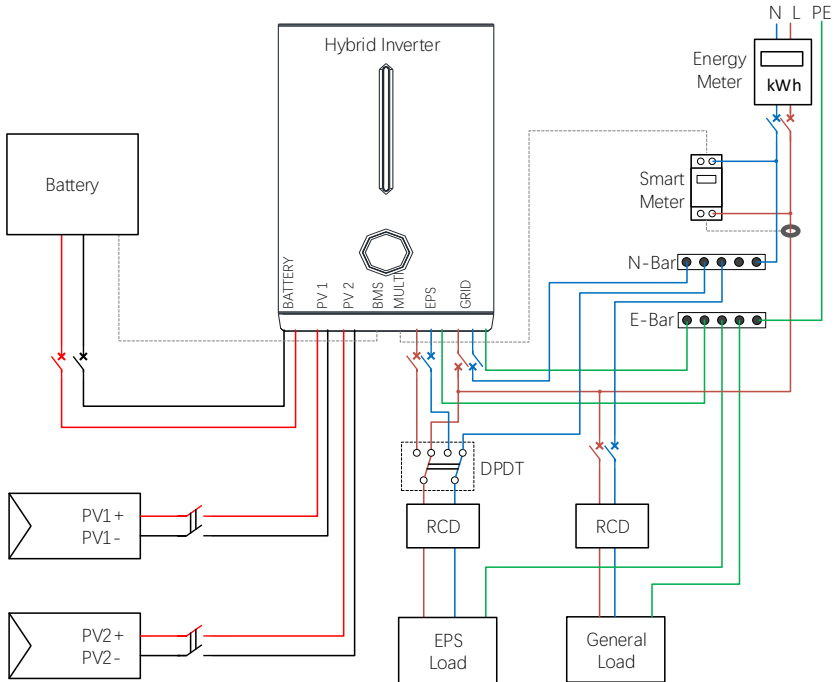

NOTICE

A built-in RCMU has been integrated in the inverter, which will exclude possibility of DC residual current to 6mA, thus type A RCDs can be used ($\geq 30\text{mA}$).

WARNING

The Netreul Line of EPS cannot be grounded or connected with Netreul Line of Grid.

6.2 Overview of the Connection Area

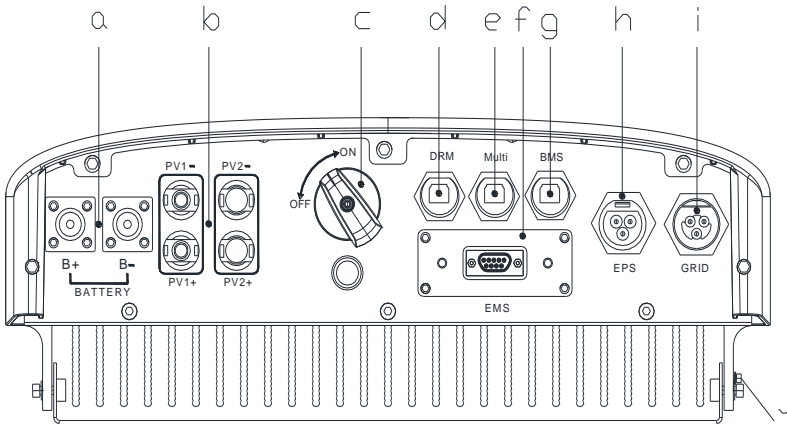

Position	Designation
a	Battery Connectors
b	PV Inputs
c	DC Switch (optional)
d	DRM Port
e	MULTI Port (for Meter & Other Communications)
f	EMS Port (for WiFi Stick or other EMS Controllers)
g	BMS Port
h	EPS Output
i	Grid Connector
j	Additional Grounding Point

6.3 PV Connection

Please only use the PV connector from the accessory box for connection.

Before connecting, please make sure:

- The voltage, current and power ratings of the panels to be connected are within the allowable range of the inverter, ensure polarity is correct, please refer to the Technical Data in chapter 9 for voltage and current limits.
- Since the inverter is transformerless, please do not ground either output of the PV panels. Ground the panel frames.
- The 3.68kW/5kW inverter is designed with 2 MPPT trackers, if the inputs of the PV panels are paralleled, please consult with your local distributor for technical support.
- If the inverter is equipped with an PV switch, please make sure it is in the “off” position. Otherwise please use an external PV switch to cut off the PV connection during wiring and when necessary.

Procedure:



- Use IEC61730 class-A Rating PV modules.
 - When exposed to light, PV panels will generate DC voltage. Turn off the PV switch before connecting the wire.
-

STEP 1:

- Assemble the PV connectors from the accessory box.
- Make sure the polarity is correct.

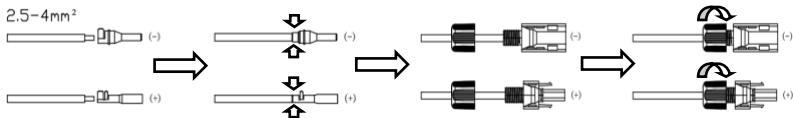

STEP 2:

- Connect the PV connectors to the inverter. There should be a “click” to indicate firm connection.

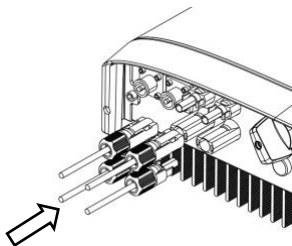

6.4 Grid Connection

Please use the Grid connector from the accessory box for connection. Before connecting, please make sure:

- The grid voltage and frequency must be in the permissible range.
- External AC switches ($\geq 40A$) must be used on both Grid connection to cut off the inverter from Grid when necessary.

Procedure:

STEP 1:

- Assemble the Grid connector.
- Make sure Live/Neutral/PE wire are correct, please follow the markings on the connector.

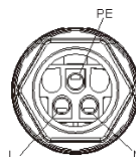

STEP 2:

- Connect the Grid plug to the inverter. If you are doing this right, there should be a “click” sound.

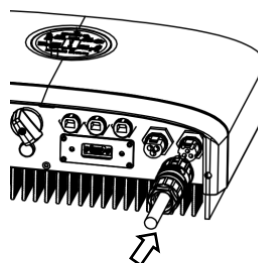

STEP 3:

- Connect an additional grounding wire to the heatsink and fasten the screw.

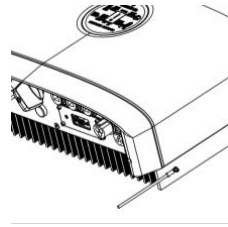

 WARNING**High leakage current!**

- Earth connection essential before connecting supply.
-

6.5 EPS Connection

If you want to use the energy storage system to power the house (as a standalone system or during Grid failure), the EPS connector should be used and the EPS function should be enabled in setup. Otherwise you could leave the EPS port un-connected.

Before connecting, please make sure:

- The grid voltage and frequency must be in the permissible range.
- External AC switches must be used on EPS connection to cut off the inverter from EPS load when necessary.

Procedure:

STEP 1:

- Assemble the EPS connector.
- Make sure Live/Neutral/PE wire is correct, please follow the markings on the connector.

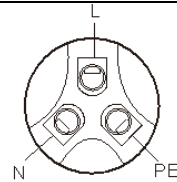

STEP 2:

- Connect the EPS plug to the inverter. A "click" sound will indicate firm connection.

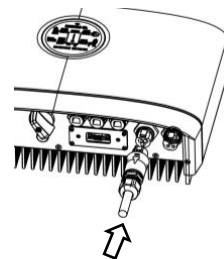

6.6 Battery Connection

Battery connection diagram

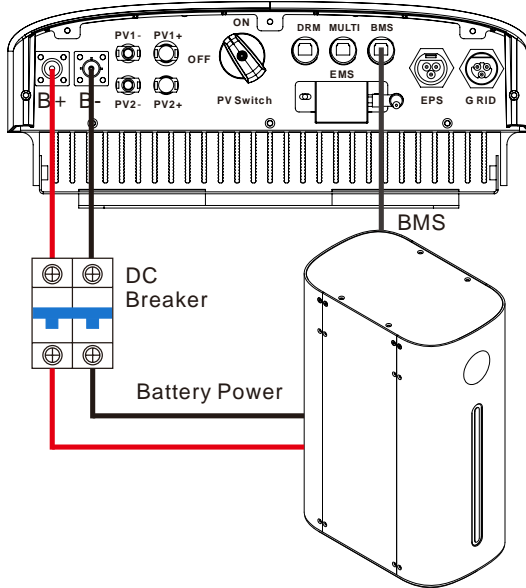

6.6.1 Battery Power Connection

Procedure:

STEP 1:

- Please use the pre-assembled battery power wire in the accessory box for connection.

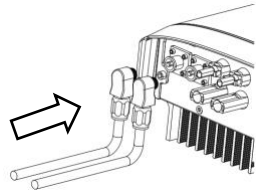

STEP 2:

- The connector from wire to battery is not assembled, you need to contact with your battery vendor for detailed information.

CAUTION

A DC breaker with OCP function is compulsory to be installed between inverter and battery. The battery may have this

switch integrated. If not, an external DC switch of proper ratings should be used.

6.6.2 BMS Communication Connection

Please check whether the BMS communication cable in the accessory box is appropriate for the battery. If you are not sure for that, please confirm with your battery vendor.

Procedure:

STEP 1:

- Please insert the RJ45 connector with water-proof cap into the port marked with "BMS" on inverter and fasten the cap.

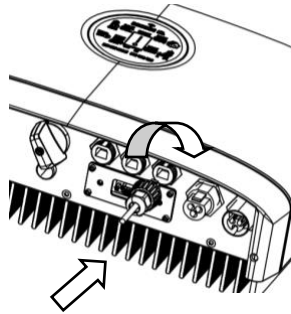

STEP 2:

- Please insert the other end of the cable in the corresponding port in battery.
-

BMS Connector Pin Definition:

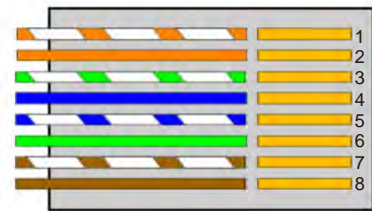

1. BMS_CAN_H
2. BMS_CAN_L
3. BMS_485_A
4. GND
5. BMS_485_B
6. GND
7. NULL
8. NULL

6.7 Smart Meter Connection

Procedure:

STEP 1:

- Normally the smart meter should be placed in or near the grid distribution box right after the billing meter.
-

STEP 2:

- Please use the smart meter cable in the accessory box for communication. Insert the RJ45 connector with water-proof cap into the port marked "MULTI" on inverter and fasten the cap.

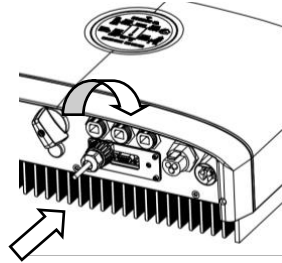

STEP 3:

- The wires on the other end should be stripped and connected to the smart meter accordingly. If the cable length is not enough, please use the RJ45 extender in accessory box to extend the cable.
-

CAUTION

3 pieces of terminal resistors (120Ohm, 240Ohm, 510Ohm) are provided with the smart meter. One can choose a suitable terminal resistor to extend the communication distance between the meter and inverter, according to site situations. The follow are typical distances and corresponding resistors for reference:

Distance < 10m, no resistor is needed;

10m < distance < 30m, 120Ohm resistor;

Distance > 30m, 240Ohm or 510Ohm resistor.

"MULTI" Connector Pin Definition

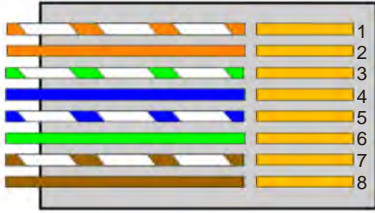

1. METER_485B
2. METER_485A
3. GND
4. Reserved
5. Reserved
6. GND
7. Reserved
8. Reserved

Smart meter type: CHINT DDSU666-D

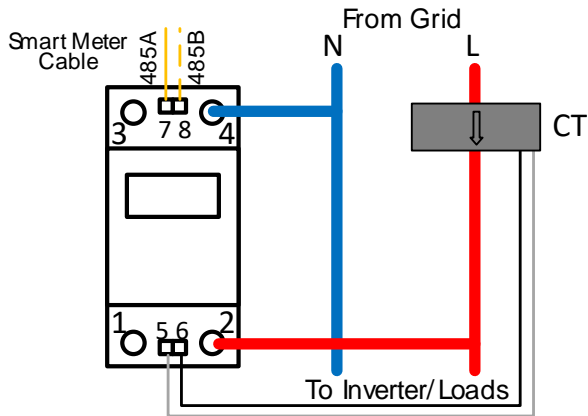

6.8 WiFi Stick Connection

Procedure:

STEP 1:

- Peel off the tape that covers the EMS port.

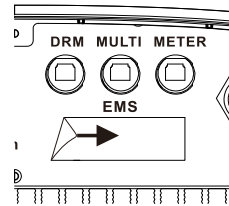

STEP 2:

- Insert the WiFi stick to the EMS port and fasten the two screws tight.

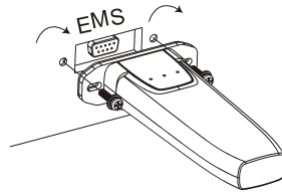

6.9 DRM Connection

DRM is provided to support several demand response modes by certain control signals.

“DRM” Connector Pin Definition

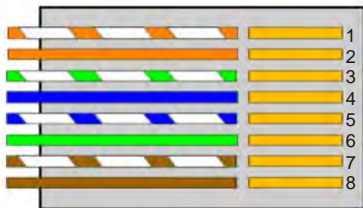

1. DRM1/5
2. DRM2/6
3. DRM3/7
4. DRM4/8
5. 3.3V
6. DRM0
7. 3.3V
8. GND

7. Operating of the Inverter

7.1 LEDs and Graphical Display

The LEDs indicate the operating state of the inverter and also battery SOC.

LED	Status	Explanation
Green LED	Glowing	The inverter has been powered up.
Red LED	Glowing	An Error has occurred.
Blue LEDs	Full Length	SOC > 75%
	3 Bars	75% > SOC > 50%
	2 Bars	50% > SOC > 25%
	1 Bar	25% > SOC > 10%
	No Light	SOC < 10% or BMS not Connected

The graphical display shows the detailed information of the inverter.

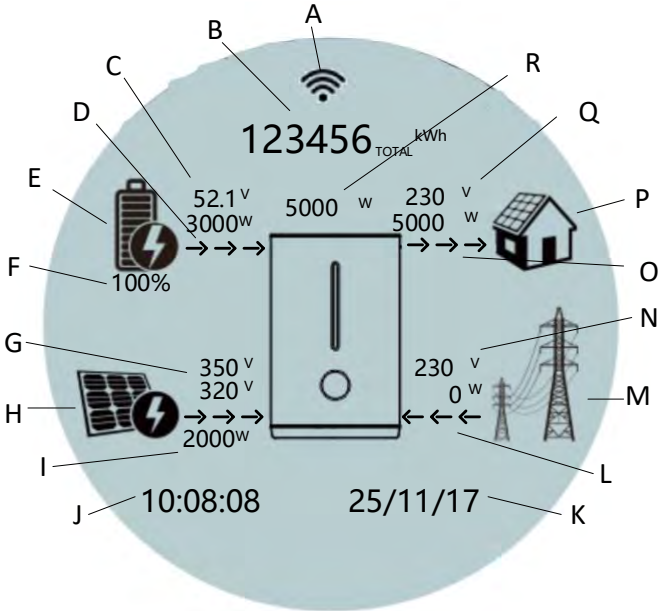

Position	Designation
A	EMS port communication status.
B	Total energy the inverter has produced.
C	Battery parameters, voltage and current are displayed alternatively.
D	Direction of the battery energy.
E	BMS Status. if this label is not shown, BMS Connections should be checked.
F	SOC of the Battery.
G	PV panels parameters, voltage and current are displayed alternatively.
H	PV panels status. If there's no PV voltage, this label will not be shown.
I	Total PV power generation
J	Default as current time, when an error occurred, fault code will be displayed alternatively.
K	Default as current date, when an error occurred, fault code will be displayed alternatively.
L	Direction of the grid power.
M	Grid status. If there's no grid, this label will not be shown.
N	Grid parameters, voltage and current are displayed alternatively.
O	Direction of the load power. If PV Inverter is installed, it could feed power back into the grid.
P	Indicating local load.
Q	Load parameters, voltage and current are displayed alternatively.
R	Current power of the inverter.

7.2 Commission

Before commissioning the inverter, make sure:

- The country mark on the box is in accordance with the installation site;
- The inverter is correctly and firmly mounted;
- The Circuit breaker and RCD are correctly connected and are all in “off” position;
- All cables are connected according to chapter 6;
- Unused inputs must be sealed using the corresponding connectors or sealing plugs.

Procedure:

STEP 1: Power on the Grid

- Wait for a while, the green led should be glowing and the graphical display should start displaying. Item “L”, “M”, “N”, should appear on the screen. If not, please power off and check for the connections of grid power line and smart meter.
-

STEP 2: Power on the Battery

- The battery icon and its parameters should be shown on the screen. If the SOC of the battery is greater than 5%, the blue LEDs should also be turned on to indicate the SOC.
-

STEP 3: Power on the PV

- If there's sunlight, the PV icon and its parameters should be shown on the screen.
 - Wait for a moment and the inverter will start a self-test procedure. When it is done successfully, the inverter will start using PV power to charge the battery or feed in power to the house and grid.
-

STEP 4: Switch on the loads

- The load parameters should show.
-

STEP 5: Configure the WiFi stick

-
- Configure the WiFi stick for remote monitoring. Please follow the instructions manual in the WiFi stick's box.
-

STEP 6: Self-test in accordance with CEI 0-21 (Italy Only)

- The self-test is only required for inverters to be commissioned in Italy. During the self-test, the inverter will consecutively check the reaction times for: overvoltage, undervoltage, maximum frequency and minimum frequency.
 - Please use the Soltaro APP to initiate the self-test procedure and get the test results. Refer to Soltaro APP Operation Instructions for details.
-

7.3 Decommission

STEP 1: Turn off the load;

STEP 2: Turn off the PV;

STEP 3: Turn off battery;

STEP 4: Turn off the main grid switch;

STEP 5: Wait for at least 5 minutes after the LED and graphical display black out for the internal circuits to discharge energy;

STEP 6: Disconnect all the power cable;

STEP 7: Disconnect all the communication cable, Remove the WiFi stick;

STEP 8: Remove the inverter from the wall, also remove the bracket if necessary;

STEP 9: Pack the inverter with the original carton, and store it.

7.4 Settings on the Soltaro APP

7.4.1 User Interface Introduction

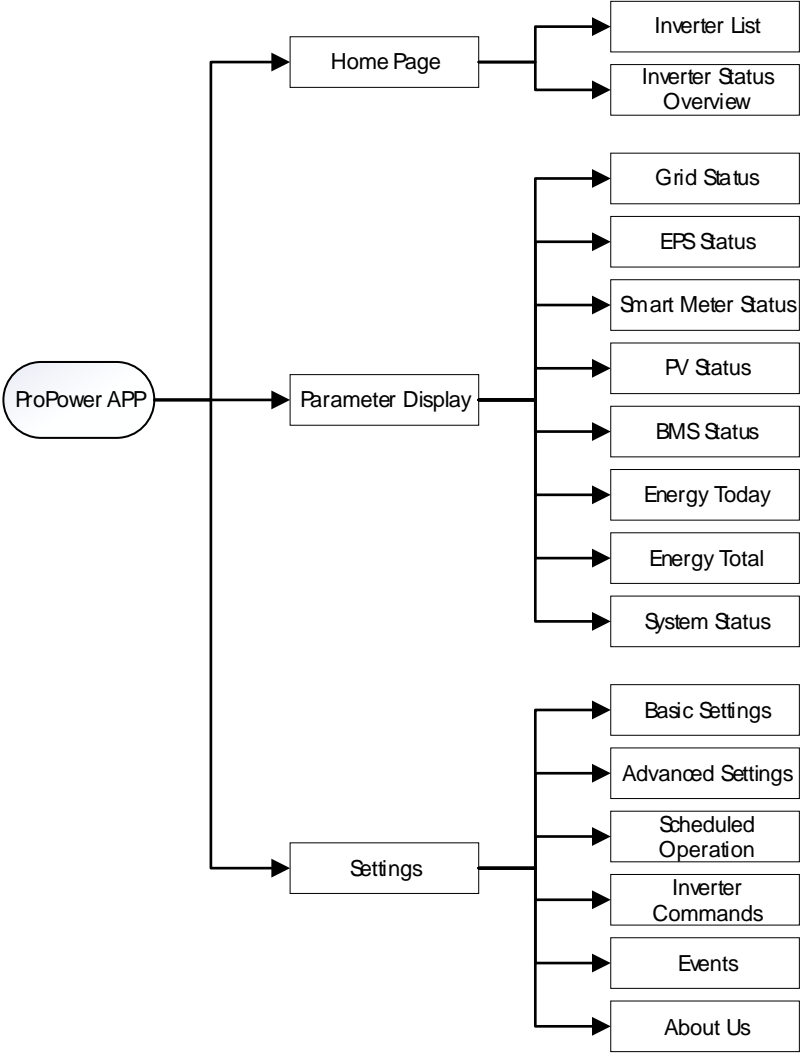

7.4.2 Install the APP and Connect to the Inverter

Procedure:

STEP 1: Install Soltaro APP

- Download the app on iOS APP Store and/or Google Play, and install it on the mobile phone or pad.

STEP 2: Connect to the inverter

- Connect the mobile phone or pad to the same wireless network (WiFi) of the inverter;
- Open the APP, click the arrow on the upper right corner of home page;
- Search the inverter ID, and connect to target inverter;
- If it is successfully connected, the home page will show the general status of the inverter. One can also check the detailed status in the Parameter interface.

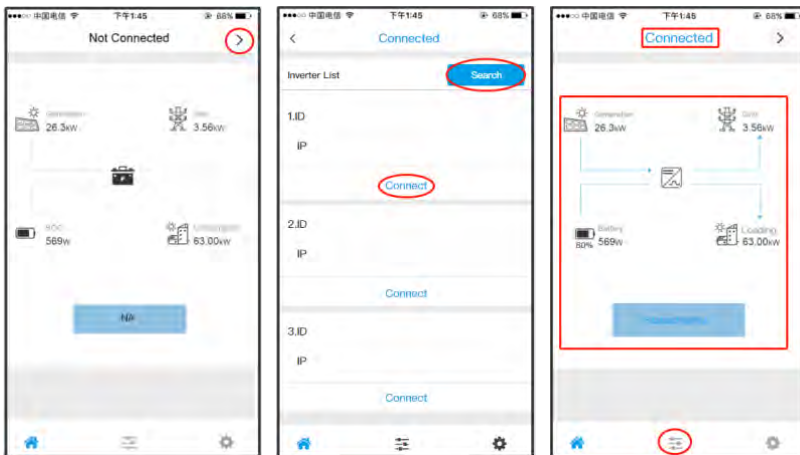

7.4.3 Check the Country

Procedure:

STEP 1: Enter the Setting interface

- Turn to Settings interface, click the “Basic Settings”;
 - Write in the password, to enter the setting interface.
-

STEP 2: Set the country

- Check the “Country”, make sure it is your current location;
 - If it is not your current location, please choose the right country, and click “Apply” to save the setting.
-

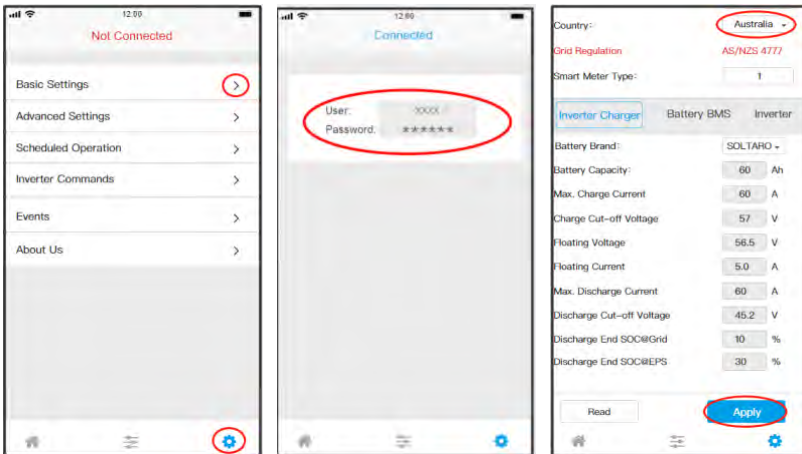

7.4.4 Time Synchronization

Procedure:

STEP 1: Enter the Setting interface

- Turn to Settings interface, click the “Inverter Commands”.

STEP 2: Time Synchronization

- Click the “Time & Date Sync.”.
-

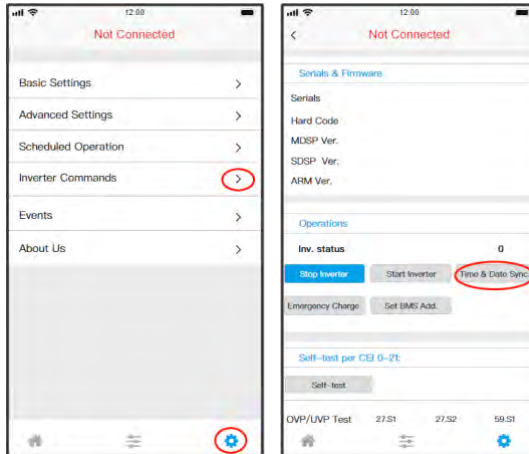

7.4.5 Self-test (for Italy only)

Procedure:

STEP 1: Enter the Setting interface

- Turn to Settings interface, click the “Inverter Commands”.

STEP 2: Self-test

- Click the “Self-test”;
- The self-test will be finished within several minutes; Normally the test results should be all “pass”;
- If there are “fails” in the test results, please do the self-test again; If still fail, please contact the distributor or manufacturer for more information.

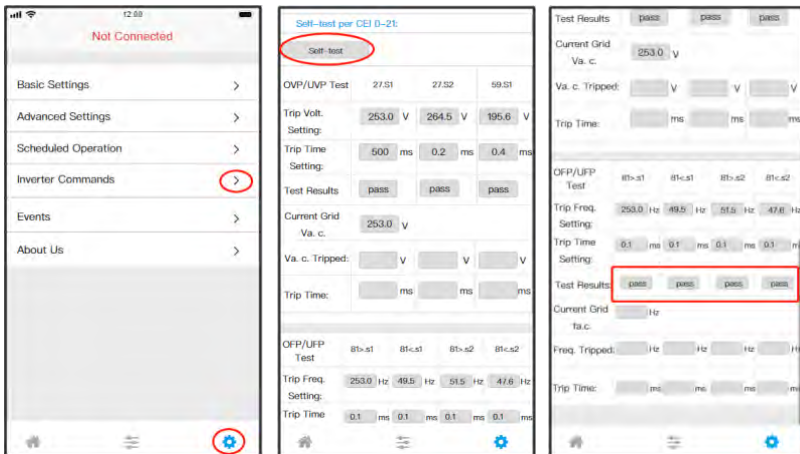

7.4.6 Battery Parallel Connection Setting

If there are more than one battery connected parallelly in the system, one should do the following settings.

Procedure:

STEP 1: Enter the Setting interface

- Turn to Settings interface, click the “Basic Settings”.

STEP 2: Set the number of paralleled batteries

- Click the “Battery BMS”;
 - Write in the number of paralleled batteries;
 - Click “Apply”, to save the settings.
-

NOTICE

This setting is only available for SOLTARO batteries.

The parallel connection of other batteries should follow instructions of corresponding battery vendors.

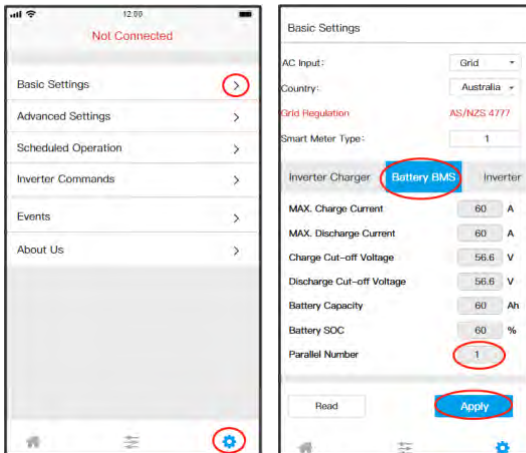

7.4.7 Scheduled Operation (optional)

Procedure:

STEP 1: Enter the Setting interface

- Turn to Settings interface, click the "Schedule Operation".

STEP 2: Set the Operation Periods and Parameter

- Enable the Scheduled Operation;
- Set the daily/weekly mode, according to your situation;
- Set the operation period and parameters, according to your requirement;
- One can also set the discharge period for the EPS mode, if necessary.
- Click "Apply" to save the setting.

NOTICE

If the scheduled periods conflict, the priority of period1 is higher than period2, which is higher than period 3, and so on.

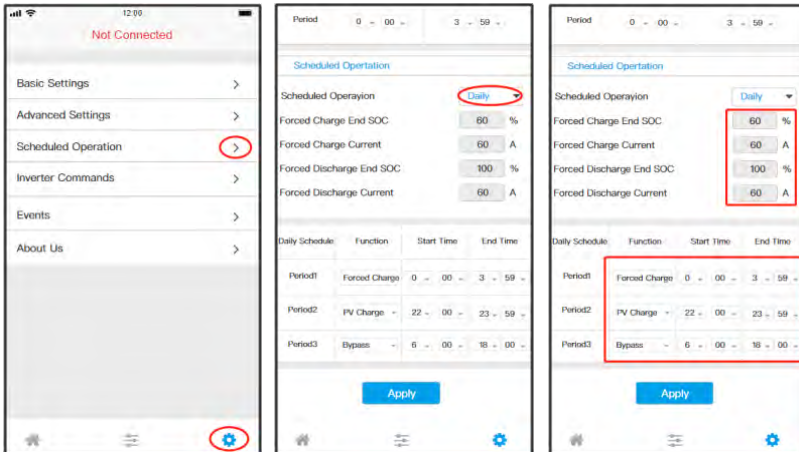

7.4.8 Other Settings (optional)

One may do the following settings, according to the situations and/or local regulations.

Settings other than the following, may also be available, but should be under the suggestions or assistance of distributors/manufacturer.

Procedure:

STEP 1: Enter the Setting interface

- Turn to Settings interface, click the “Basic Settings”.

STEP 2: Max. Charge/Discharge Current

- Click the “Battery BMS”;
- Set the max. charge/discharge current according to requirement, which should not exceed the limitation of battery;
- Click “Apply”, to save the settings.

STEP 2: Inverter Power Limitation

- Click “Inverter”;
 - Set the power limitation, according to your situation and/or local regulations;
 - Click “Apply”, to save the settings.
-

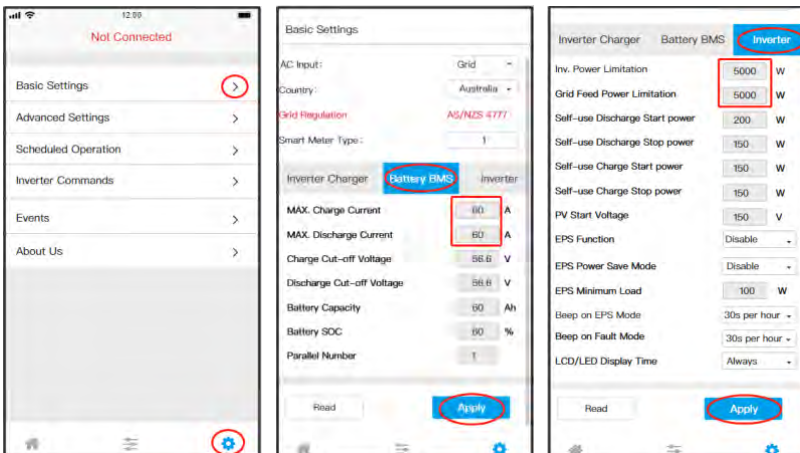

8. Troubleshooting

This chapter is a guide for troubleshooting problems that may arise in the installation and operation of hyper series inverters. In the event that more than one error is generated at the same time, the hexadecimal error corresponding to each alarm are added together. That is to say, if error code 0006H is displayed, errors 0002H and 0004H are being produced simultaneously.

Error Code	Description	Solution
F1:00000001	PV1 OVP	Check the configuration of connected PV Panels.
F1:00000002	PV1 OCPs	
F1:00000004	PV2 OVP	
F1:00000008	PV2 OCPs	
F1:00000010	PV1 OCPH	
F1:00000020	PV2 OCPH	
F1:00000100	Grid Voltage Abnormal	Check if grid fails.
F1:00000200	Grid Frequency Abnormal	
F1:00000400	DC Bus OVP	These errors will reset itself. If it keeps coming and finally the Inverter is latched up, please contact with your local distributor.
F1:00000800	AC OCPs	
F1:00001000	DC Component of AC Current Abnormal	
F1:00002000	Leakage Current Protection	
F1:00004000	AC OCPH	
F1:00010000	EPS Voltage Abnormal	
F1:00020000	EPS OCP	Check the EPS load. Unplug some to see if too much loads are connected.
F1:00040000	EPS Over Power	
F1:00080000	EPS SCP	

Error Code	Description	Solution
F1:00100000	Over Heat P1	Wait for the Inverter cools down. Check if the installation place is too hot.
F1:00200000	Over Heat P2	
F1:00400000	Over Heat P3	
F1:00800000	Bat. OTP	These errors will reset itself. If it keeps coming and finally the Inverter is latched up, please contact with your local distributor.
F1:01000000	Bat. Voltage Protection	
F1:02000000	Bat. OCP1	
F1:04000000	Bat. OCP2	
F1:08000000	Bat. OCP3	
F1:10000000	Bat. OCP4	
F1:20000000	Internal OVP1	
F1:40000000	Internal OVP2	
F1:80000000	Internal OVP3	
F2:00000001	Grid Grounding Fault	Check the grounding wire.
F2:00000002	L/N Reversely Connected	Check the L/N wire.

F2:00000004	Insulation Fault	Check the insulation of PV panels.
F2:00000008	RCMU Fault	Check the PV Panels.
F2:00000010	Grid Relay Fault	These errors will reset itself. If it keeps coming and finally the Inverter is latched up, please contact with your local distributor.
F2:00000020	EPS Relay Fault	
F2:00000040	Bypass Relay Fault	
F2:00000080	EEPROM1 Error	
F2:00000100	Single Faults	
F2:00000200	Internal Comm. F1	
F2:00000400	Internal Comm. F2	
F2:00000800	Internal Comm. F3	

Error Code	Description	Solution
F3:00000001	BMS External Fault	Check the battery for parameter settings. Contact with your local battery's distributor.
F3:00000002	BMS Internal Fault	
F3:00000004	BMS OVP	
F3:00000008	BMS UVP	
F3:00000010	BMS Charge OCP	Check the battery for parameter settings. Contact with your local battery's distributor.
F3:00000020	BMS Discharge OCP	
F3:00000040	BMS OTP	
F3:00000080	BMS UTP	
F3:00000100	Cell Imbalance	
F3:00000400	Meter Comm. Fault	Please check the communication cable for smart meter. If the length > 10m, a 120-ohm resistor should be connected to the meter.
F3:00000800	Internal Comm. F5	These errors will reset itself. If it keeps coming and finally the Inverter is latched up, please contact with your local distributor.
F3:00001000	Internal Comm. F6	
F3:00002000	EEPROM2 Error	

9. Technical Data

9.1 Hyper 2000/3000

PV Inputs	Hyper 2000	Hyper 3000
Max. PV-generator power	2500W	3300W
Max. PV voltage	550V d.c.	
Rated PV Voltage	360V d.c.	
MPPT Voltage Range	125~500V d.c.	
PV Start Voltage	100V d.c.	
Max. PV current	12A d.c.	
Max. Short Circuit Current	15A d.c.	
Strings per MPP Tracker	2	
Number of MPP Trackers	1	
Galvanic Isolation for PV Modules	Transformerless	
Reverse Current to PV Panels	No	
AC Ratings	Hyper 2000	Hyper 3000
Rated AC Power	2000VA	3000VA
Rated AC Voltage	230V a.c.	
AC Voltage Range	180V~264V a.c.	
Rated AC Frequency	50Hz/60Hz	
Max. AC Current to Grid (Feed Back Current)	8.7A a.c.	13A a.c.
Max. AC Current from Grid (Bypass + Grid Charge)	17.4A a.c.	26A a.c.
Max. Output Overcurrent Protection	25A a.c.	32A a.c.
Power Factor Range	-0.8~+0.8	
Total Harmonic Distortions (I)	<3%	
Inrush Current (Peak/Duration)	120A/32us	
Max. Output Fault Current (Peak/Duration)	200A/10ms	
EPS Ratings	Hyper 2000	Hyper 3000
EPS Rated Power	2000VA	3000VA
Overload Capacity	1.1 x Pnom, 10 sec; 1.5 x Pnom, 100 ms	
EPS Rated Voltage	230V a.c.	
EPS Rated Frequency	50Hz / 60Hz	
EPS Rated Current	8.7A	13A
Changeover Time	<2s in EPS Mode, 10~20ms in UPS Mode	
Total Harmonic Distortion (V)	< 3%	
Parallel Operation	No	

Battery Ratings	Hyper 2000	Hyper 3000
Battery Type	Lithium	
Rated Battery Voltage	48V d.c.	
Battery Voltage Range	40~60V d.c.	
Max. Charge Current	40A d.c.	60A d.c.
Max. Discharge Current	40A d.c.	60A d.c.
PS Max. (per CEI 0-21)	1900W	2800W
PC Max. (per CEI 0-21)	2000W	3000W
Galvanic Isolation for Battery	YES	
Communication Interfaces	CAN/RS485	
Efficiencies	Hyper 2000	Hyper 3000
MPPT Efficiency	99.9%	99.9%
Euro Efficiency	97.0%	97.0%
Max. Efficiency	97.5%	97.5%
Max. PV to Bat. Efficiency	95%	95%
Max. PV to AC Efficiency	94%	94%
Protections	Hyper 2000	Hyper 3000
OVP/UVP	YES	YES
OCP/OLP	YES	YES
PV Insulation Protection	YES	YES
Grounding Fault Monitoring	YES	YES
Grid Protection	YES	YES
DC Injection Protection	YES	YES
Back Feed Current Monitoring	YES	YES
Residual Current Detection	YES	YES
Anti-islanding Protection	YES	YES
General	Hyper 2000	Hyper 3000
Dimensions (LxHxD)	415*560*145mm	
Weight	28kg	28kg
Mounting Type	Wall Mount	
Operating Temperature	-20~+60 Degree C	
Storage Temperature	-20~+60 Degree C	
Humidity	4%~100%, Condensing	
Ingress Protection	IP65 (outdoor)	
Protective Class	I	
Over Voltage Category	III (mains), II(PV)	
Pollution Degree	III	
Cooling Method	Natural	
Noise Level	<40dB	

9.2 Hyper 3680/4600/5000

PV Inputs	Hyper 3680	Hyper 4600	Hyper 5000
Max. PV-generator power	4000VA	5400VA	5400VA
Max. PV voltage		550V d.c.	
Rated PV Voltage		360V d.c.	
MPPT Voltage Range		125~500V d.c.	
PV Start Voltage		100V d.c.	
Max. PV current		10A/10A d.c.	
Max. Short Circuit Current		14A/14A d.c.	
Strings per MPP Tracker		1	
Number of MPP Trackers		2	
Galvanic Isolation for PV Modules		Transformerless	
Reverse Current to PV Panels		No	
AC Ratings	Hyper 3680	Hyper 4600	Hyper 5000
Rated AC Power	3680VA	4600VA	5000VA
Rated AC Voltage		230V a.c.	
AC Voltage Range		180V~264V a.c.	
Rated AC Frequency		50Hz/60Hz	
Max. AC Current to Grid (Feed Back Current)	16A a.c.	20A a.c.	21.7A a.c.
Max. AC Current from Grid (Bypass + Grid Charge)	30A a.c.	30A a.c.	30A a.c.
Max. Output Overcurrent Protection	40A a.c.	40A a.c.	40A a.c.
Power Factor Range		-0.8~+0.8	
Total Harmonic Distortions (i)		<3%	
Inrush Current (Peak/Duration)		120A/32us	
Max. Output Fault Current (Peak/Duration)		200A/10ms	
EPS Ratings	Hyper 3680	Hyper 4600	Hyper 5000
EPS Rated Power	4000VA	5000VA	5000VA
Overload Capacity	1.1 x P _{nom} , 10 sec; 1.5 x P _{nom} , 100 ms		
EPS Rated Voltage		230V a.c.	
EPS Rated Frequency		50Hz/60Hz	
EPS Rated Current	17.4A	21.7A	21.7A
Changeover Time	2s in EPS Mode, 10ms in UPS Mode		
Total Harmonic Distortion (V)		< 3%	
Parallel Operation		No	
Battery Ratings	Hyper 3680	Hyper 4600	Hyper 5000
Battery Type		Lithium	
Rated Battery Voltage		48V d.c.	
Battery Voltage Range		40~60V d.c.	

Max. Charge Current	60A d.c.	100A d.c.	100A d.c.
Max. Discharge Current	60A d.c.	100A d.c.	100A d.c.
PS Max. (per CEI 0-21)	2800W	4600W	4700W
PC Max. (per CEI 0-21)	3600W	4600W	5000W
Galvanic Isolation for Battery	YES		
Communication Interfaces	CAN/RS485		
Efficiencies	Hyper 3680	Hyper 4600	Hyper 5000
MPPT Efficiency	99.9%	99.9%	99.9%
Euro Efficiency	97.0%	97.0%	97.0%
Max. Efficiency	97.5%	97.5%	97.5%
Max. PV to Bat. Efficiency	95%	95%	95%
Max. PV to AC Efficiency	94%	94%	94%
Protections	Hyper 3680	Hyper 4600	Hyper 5000
OVP/UVP	YES	YES	YES
OCP/OLP	YES	YES	YES
PV Insulation Protection	YES	YES	YES
Grounding Fault Monitoring	YES	YES	YES
Grid Protection	YES	YES	YES
DC Injection Protection	YES	YES	YES
Back Feed Current Monitoring	YES	YES	YES
Residual Current Detection	YES	YES	YES
Anti-islanding Protection	YES	YES	YES
General	Hyper 3680	Hyper 4600	Hyper 5000
Dimensions (LxHxD)	415*675*145mm		
Weight	33kg	35kg	35kg
Mounting Type	Wall Mount		
Operating Temperature	-20~+60 Degree C		
Storage Temperature	-20~+60 Degree C		
Humidity	4%~100%, Condensing		
Ingress Protection	IP65 (outdoor)		
Protective Class	I		
Over Voltage Category	III (mains), II(PV)		
Pollution Degree	III		
Cooling Method	Natural		
Noise Level	<40dB		

9.3 Certificates and Grid Regulations

- **EMC:**

EN61000-6-1, EN61000-6-2, EN61000-6-3, EN61000-6-4, EN61000-4-16, EN61000-4-18, EN61000-4-29

- **Safety:**

IEC/EN62109-1 & -2,

IEC62040-1

- **Grid Regulations:**

G83/2, G59/3;

AS/NZS4777.2;

C10/11;

CEI 0-21;

RD1699;

C 15-712-1;

VDE-AR-N 4105;

EN50438/NL;

EN50438/IE.

Contacts:

Head Office

Level 9, 440 Collins Street, Melbourne, Australia 3043
+61 1300 276 582

UK Office

Unit 8, High Grounds Industrial Est., Worksop, Nottinghamshire, S80
3AF, United Kingdom
+44 (0)1909 807 577

China Office

No. 200 Linghu Road, Wuxi 214100, China

Europe Office

Porta Piazzetta, 2 GR-6537, San Vittore – Switzerland (0)

